



User Manual

Congratulations on the purchase of your new T-Mobile Shadow.

Please Read Before Proceeding.

THIS PHONE IS NOT FULLY CHARGED WHEN YOU TAKE IT OUT OF THE BOX.

DO NOT REMOVE THE BATTERY PACK WHEN THE PHONE IS CHARGING.

YOUR WARRANTY IS INVALIDATED IF YOU OPEN OR TAMPER WITH THE PHONE'S OUTER CASING.

PRIVACY RESTRICTIONS

Some countries require full disclosure of recorded telephone conversations, and stipulate that you must inform the person with whom you are speaking that the conversation is being recorded. Always obey the relevant laws and regulations of your country when using the recording feature of your phone.

COPYRIGHT INFORMATION

Copyright © 2008 T-Mobile. All Rights Reserved.

T-Mobile, the magenta color, and the HotSpot design are federally registered trademarks of Deutsche Telekom AG. myFaves and the myFaves design are federally registered trademarks and , of T-Mobile USA, Inc.

Microsoft, MS-DOS, Windows, Windows NT, Windows Server, Windows Mobile, Windows XP, Windows Vista, ActiveSync, Windows Mobile Device Center, Internet Explorer, Windows Live, MSN, Hotmail, Outlook, Excel, PowerPoint, Word, and Windows Media are either registered trademarks or trademarks of Microsoft Corporation in the United States and/or other countries.

Bluetooth and the Bluetooth logo are trademarks owned by Bluetooth SIG, Inc.

Wi-Fi is a registered trademark of the Wireless Fidelity Alliance, Inc.

microSD is a trademark of SD Card Association.

Java, J2ME and all other Java-based marks are trademarks or registered trademarks of Sun Microsystems, Inc. in the United States and other countries.

Copyright © 2008, Adobe Systems Incorporated.

Copyright © 2008, Macromedia Netherlands, B.V.

Macromedia, Flash, Macromedia Flash, Macromedia Flash Lite and Reader are trademarks and/or registered trademarks of Macromedia Netherlands, B.V. or Adobe Systems Incorporated.

Copyright © 2008, JATAAYU SOFTWARE (P) LTD. All Rights Reserved.

Copyright © 2008, Dilithium Networks, Inc. All Rights Reserved.

ArcSoft MMS Composer™ Copyright © 2003-2008, ArcSoft, Inc. and its licensors. All Rights Reserved. ArcSoft and the ArcSoft logo are registered trademarks of ArcSoft, Inc. in the United States and/or other countries.

Licensed by QUALCOMM Incorporated under one or more of the following patents:

4,901,307 ; 5,490,165 ; 5,056,109 ; 5,504,773 ; 5,101,501 ; 5,778,338 ; 5,506,8655,109,390 ; 5,511,073 ; 5,228,054 ; 5,535,239 ; 5,710,784 ; 5,267,261 ; 5,544,1965,267,262 ; 5,568,483 ; 5,337,338 ; 5,659,569 5,600,754 ; 5,414,796 ; 5,657,420 ; 5,416,797

This device is licensed under patented keyboard technology of Research In Motion Limited including the following US Patents and foreign counterparts: 6,278,442; 6,396,482; 6,452,588; 6,489,950; 6,611,254; 6,611,255; 6,876,763; 6,873,317; 6,891,529; 6,919,879; 7,056,043; 7,073,964; 7,106,306; 7,113,111; 7,153,049; 7,158,120; 7,227,536; 6,891,529; 7,083,342; 7,096,036; 7,106,306; 7109973; and 7,220,069.

All other company, product and service names mentioned herein are trademarks, registered trademarks or service marks of their respective owners.

T-Mobile shall not be liable for technical or editorial errors or omissions contained herein, nor for incidental or consequential damages resulting from furnishing this material. The information is provided "as is" without warranty of any kind and is subject to change without notice. T-Mobile also reserves the right to revise the content of this document at any time without prior notice.

No part of this document may be reproduced or transmitted in any form or by any means, electronic or mechanical, including photocopying, recording or storing in a retrieval system, or translated into any language in any form without prior written permission of T-Mobile.

Important Health Information and Safety Precautions

When using this product, the safety precautions below must be taken to avoid possible legal liabilities and damages. Retain and follow all product safety and operating instructions. Observe all warnings in the operating instructions on the product.

To reduce the risk of bodily injury, electric shock, fire, and damage to the equipment, observe the following precautions.

ELECTRICAL SAFETY

This product is intended for use when supplied with power from the designated battery or power supply unit. Other usage may be dangerous and will invalidate any approval given to this product.

SAFETY PRECAUTIONS FOR PROPER GROUNDING INSTALLATION

CAUTION: Connecting to improperly grounded equipment can result in an electric shock to your device.

This product equipped with a USB Cable for connecting with a desktop or notebook computer. Be sure your computer is properly grounded (earthed) before connecting this product to the computer. The power supply cord of a desktop or notebook computer has an equipment-grounding conductor and a grounding plug. The plug must be plugged into an appropriate outlet which is properly installed and grounded in accordance with all local codes and ordinances.

SAFETY PRECAUTIONS FOR POWER SUPPLY UNIT

- **Use the correct external power source**

A product should be operated only from the type of power source indicated on the electrical ratings label. If you are not sure of the type of power source required, consult your authorised service provider or local power company. For a product that operates from battery power or other sources, refer to the operating instructions that are included with the product.

This product should be operated only with the following designated power supply unit(s).

AC Adapter

1. Delta, Model **EADP-5GB X**
2. Phihong, Model **PSAA05X-050**

- **Handle battery packs carefully**

This product contains a Li-ion battery. There is a risk of fire and burns if the battery pack is handled improperly. Do not attempt to open or service the battery pack. Do not disassemble, crush, puncture, short external contacts or circuits, dispose of in fire or water, or expose a battery pack to temperatures higher than **140°F**.



WARNING: DANGER OF EXPLOSION IF BATTERY IS INCORRECTLY REPLACED. TO REDUCE RISK OF FIRE OR BURNS, DO NOT DISASSEMBLE, CRUSH, PUNCTURE, SHORT EXTERNAL CONTACTS, EXPOSE TO TEMPERATURE ABOVE 140°F, OR DISPOSE OF IN FIRE OR WATER. REPLACE ONLY WITH SPECIFIED BATTERIES. RECYCLE OR DISPOSE OF USED BATTERIES ACCORDING TO THE LOCAL REGULATIONS OR REFERENCE GUIDE SUPPLIED WITH YOUR PRODUCT.



NOTE: This product should be operated only with the following designated Battery Pack:

- **TWS, Model CONV160**

- **Take extra precautions**

- Keep the battery or device dry and away from water or any liquid as it may cause a short circuit.
- Keep metal objects away so they don't come in contact with the battery or its connectors as it may lead to short circuit during operation.
- Do not use a battery that appears damaged, deformed, or discolored, or one that has any rust on its casing, overheats, or emits a foul odor.
- Always keep the battery out of the reach of babies and small children, to avoid swallowing of the battery. Consult the doctor immediately if the battery is swallowed.

- If the battery leaks:
 - Do not allow the leaking fluid to come in contact with skin or clothing. If already in contact, flush the affected area immediately with clean water and seek medical advice.
 - Do not allow the leaking fluid to come in contact with eyes. If already in contact, DO NOT rub; rinse with clean water immediately and seek medical advice.
 - Take extra precautions to keep a leaking battery away from fire as there is a danger of ignition or explosion.
- Communicate the appropriate steps immediately in case a hazard occurs.

SAFETY PRECAUTIONS FOR DIRECT SUNLIGHT

Keep this product away from excessive moisture and extreme temperatures. Do not leave the product or its battery inside a vehicle or in places where the temperature may exceed **140°F**, such as on a car dashboard, window sill, or behind a glass that is exposed to direct sunlight or strong ultraviolet light for extended periods of time. This may damage the product, overheat the battery, or pose a risk to the vehicle.

PREVENTION OF HEARING LOSS



CAUTION: Permanent hearing loss may occur if earphones or headphones are used at high volume for prolonged periods of time.

SAFETY IN AIRCRAFT

Due to the possible interference caused by this product to an aircraft's navigation system and its communications network, using this device's phone function on board an airplane is against the law in most countries. If you want to use this device when on board an aircraft, remember to turn off the phone by switching to Flight Mode.

ENVIRONMENTAL RESTRICTIONS

Do not use this product in gas stations, fuel depots, chemical plants or where blasting operations are in progress, or in potentially explosive atmospheres such as fuelling areas, fuel storehouses, below deck on boats, fuel or chemical transfer or storage facilities, and areas where the air contains chemicals or particles, such as grain, dust, or metal powders. Please be aware that sparks in such areas could cause an explosion or fire resulting in bodily injury or even death.

EXPLOSIVE ATMOSPHERES

When in any area with a potentially explosive atmosphere or where flammable materials exist, the product should be turned off and the user should obey all signs and instructions. Sparks in such areas could cause an explosion or fire resulting in bodily injury or even death. Users are advised not to use the equipment at refueling points such as service or gas stations, and are reminded of the need to observe restrictions on the use of radio equipment in fuel depots, chemical plants, or where blasting operations are in progress. Areas with a potentially explosive atmosphere are often, but not always, clearly marked. These include fueling areas, below deck on boats, fuel or chemical transfer or storage facilities, and areas where the air contains chemicals or particles, such as grain, dust, or metal powders.

ROAD SAFETY

In some states or local jurisdictions, vehicle drivers in motion are not permitted to use telephony services with handheld devices, except in the case of emergency. In some countries outside the US, using hands-free devices as an alternative is allowed.

SAFETY PRECAUTIONS FOR RF EXPOSURE

- Avoid using your device near metal structures (for example, the steel frame of a building).
- Avoid using your device near strong electromagnetic sources, such as microwave ovens, sound speakers, TV and radio.
- Use only original manufacturer-approved accessories, or accessories that do not contain any metal.
- Use of non-original manufacturer-approved accessories may violate your local RF exposure guidelines and should be avoided.

INTERFERENCE WITH MEDICAL EQUIPMENT

This product may cause medical equipment to malfunction. The use of this device is forbidden in most hospitals and medical clinics.

If you use any other personal medical device, consult the manufacturer of your device to determine if it is adequately shielded from external RF energy. Your physician may be able to assist you in obtaining this information.

Turn the phone OFF in health care facilities when any regulations posted in these areas instruct you to do so. Hospitals or health care facilities may be using equipment that could be sensitive to external RF energy.

HEARING AIDS

Some digital wireless phones may interfere with some hearing aids. In the event of such interference, you may want to consult your service provider, or call the customer service line to discuss alternatives.

NONIONIZING RADIATION

Your device has an internal antenna. This product should be operated in its normal-use position to ensure the radiative performance and safety of the interference. As with other mobile radio transmitting equipment, users are advised that for satisfactory operation of the equipment and for the safety of personnel, it is recommended that no part of the human body be allowed to come too close to the antenna during operation of the equipment.

Use only the supplied integral antenna. Use of unauthorized or modified antennas may impair call quality and damage the phone, causing loss of performance and SAR levels exceeding the recommended limits as well as result in non-compliance with local regulatory requirements in your country.

General Precautions

- **Heed service markings**

Except as explained elsewhere in the Operating or Service documentation, do not service any product yourself. Any necessary services on components inside these compartments should be done by an authorized service technician or provider.

- **Damage requiring service**

Unplug the product from any electrical power source and refer servicing to an authorized service technician or provider under the following conditions:

- Liquid has been spilled or an object has fallen into the product.
- The product has been exposed to rain or water.

The LDI (Liquid Damage Indicator) is a circular label that changes color, from white to red, when the phone's sensitive area (e.g. battery contacts) is exposed to water.

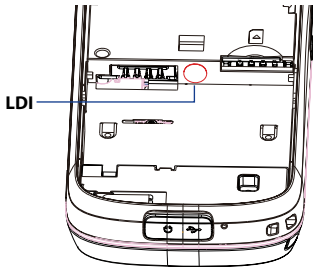

- The product has been dropped or damaged.
- There are noticeable signs of overheating.
- The product does not operate normally when you follow the operating instructions.
- **Avoid hot areas**
The product should be placed away from heat sources such as radiators, heat registers, stoves, or other products (including, but limited to, amplifiers) that produce heat.
- **Avoid wet areas**
Never use the product in a wet location.

- **Avoid using your device after a dramatic change in temperature**

When you move your device between environments with very different temperature and/or humidity ranges, condensation may form on or within the device. To avoid damaging the device, allow sufficient time for the moisture to evaporate before using the device.

NOTE: When taking the device from low-temperature conditions into a warmer environment or from high-temperature conditions into a cooler environment, allow the device to acclimate to room temperature before turning on the power.

- **Avoid pushing objects into product**

Never push objects of any kind into cabinet slots or other openings in the product. Slots and openings are provided for ventilation. These openings must not be blocked or covered.

- **Mounting Accessories**

Do not use the product on an unstable table, cart, stand, tripod, or bracket. Any mounting of the product should follow the manufacturer's instructions, and should use a mounting accessory recommended by the manufacturer.

- **Avoid unstable mounting**

Do not mount or place the product on an unstable base.

- **Use product with approved equipment**

This product should be used only with personal computers and/or options identified as suitable for use with your equipment.

- **Adjust the volume**

Turn down the volume before using headphones or other audio devices.

- **Cleaning**

Unplug the product from the wall outlet before cleaning. Do not use liquid cleaners or aerosol cleaners. Use a damp cloth for cleaning, but NEVER use water to clean the LCD screen.

Contents

Welcome to T-Mobile®	21
Introduction	22
T-Mobile Services and Applications	23
Voice/Phone	23
Voicemail	24
E-mail	24
Messaging services	24
T-Mobile myFaves®	25
T-Mobile HotSpot	26
Mobile Backup	26
International Service	26
Activating Service	27
Chapter 1 Getting Started	29
1.1 Getting to Know Your Phone and Its Accessories	30
1.2 Inserting the SIM Card	35
1.3 Installing a microSD Card	37
1.4 Charging the Battery	38
1.5 Turning On the Phone	39
1.6 Using the Headset / Charging Cable	40
1.7 The Home Screen	41
Shortcut Bar	42
1.8 Programs On Your Phone	46
1.9 Using the Start Menu	51

1.10	Using the Quick List.....	51
1.11	Entering Information	52
	Input modes.....	52
	The 20-key QWERTY keyboard	53
	Multipress mode.....	54
	T9 mode	54
	Numeric mode	56
1.12	Battery Information	57
1.13	Shortcut Key.....	58
1.14	Status Indicators	59

Chapter 2 Using Phone Features 61

2.1	Using the Phone.....	62
	The Phone screen.....	62
	Set ring tones.....	62
2.2	Making a Call.....	63
	Make a call from the Home screen.....	63
	Make a call from Contacts	64
	Make a call from Call History.....	64
	Make a call from Speed Dial	65
	Make a call from SIM Manager	65
2.3	Receiving a Call.....	66
2.4	In-Call Options.....	67
2.5	Additional Dialing Information.....	69
	Make an emergency call	69
	Make an international call.....	69
	Insert a pause or long pause in a dialing sequence	69

Chapter 3 Synchronizing Information with Your Computer 71

3.1 About Synchronization.....	72
Ways to synchronize.....	72
3.2 Setting Up Windows Mobile® Device Center on Windows Vista.....	73
Set up synchronization in Windows Mobile® Device Center	73
3.3 Setting Up ActiveSync® on Windows XP	74
Install ActiveSync®	74
Set up synchronization in ActiveSync®	74
3.4 Synchronizing With Your Computer.....	75
Start and stop synchronization	75
Change which information is synchronized.....	76
Troubleshoot sync connection problems	76
3.5 Synchronizing via Bluetooth	77
3.6 Synchronizing Music and Video	78

Chapter 4 Managing your Phone 79

4.1 Personalizing Your Phone	80
Set up the Home screen	80
Set date, time, and other regional options	81
Choose how to be notified about events or actions	81
Set personal information.....	83
Set performance and maintenance options	83
4.2 Adding and Removing Programs.....	85
4.3 Using Task Manager and Managing Memory.....	85
4.4 Managing and Backing Up Files.....	86
Copy files to a PC using Windows Mobile® Device Center or ActiveSync®	86

Use File Explorer	87
4.5 Protecting Your Phone	88
4.6 Restarting Your Phone	92
4.7 Resetting Your Phone	92

Chapter 5 Organizing Phone Information..... 93

5.1 Contacts	94
Create a contact on your phone	94
Edit and call a contact	95
Find a contact	95
Share contact information	96
5.2 SIM Manager.....	97
5.3 T-Mobile myFaves®	99
T-Mobile myFaves on the Home screen	99
Add myFaves contacts.....	100
Rotate and crop a photo	101
Call a myFaves contact	102
myFaves settings	103
Edit a myFaves contact.....	104
5.4 Calendar.....	105
Create a personal appointment.....	105
View your appointments.....	106
Send appointments.....	107
5.5 Tasks.....	108
5.6 Mobile Backup	109
5.7 Voice Recorder	110

Chapter 6 Exchanging Messages.....	111
6.1 Messaging	112
6.2 Text Messages	113
Compose and send text messages	113
Manage text messages	114
Receive text messages	116
Copy and paste text	116
6.3 Picture Messages	117
Create and send Picture Messages	117
View, reply to and block Picture Messages	119
6.4 Audio Postcards.....	121
6.5 Use Instant Messaging.....	122
AIM®	122
ICQ®	124
Yahoo!®	125
Windows Live™ Messenger.....	126
6.6 Set Up E-Mail.....	127
6.7 Use E-mail.....	129
Create and reply to e-mails.....	129
Filter the Inbox message list.....	130
Send and download e-mails	132
Customize e-mail settings.....	133
6.8 Use Keyboard Shortcuts.....	135
 Chapter 7 Working with Company E-mails and Meeting	
Appointments	137
7.1 Synchronizing Your Phone with the Exchange Server	138

Set up an Exchange Server connection from your phone	138
Set up an Exchange Server connection from your PC	140
Start synchronization.....	144
7.2 Working with Company E-mails	145
Automatic synchronization through Direct Push.....	145
Scheduled synchronization	147
Instant download through Fetch Mail.....	147
Search for e-mails on the Exchange Server	148
Flag your messages	149
Out-of-office auto-reply.....	150
View a document linked to an e-mail message	150
7.3 Managing Meeting Requests	151
7.4 Finding Contacts in the Company Directory	153
7.5 E-mail Security	155
Encrypt and sign messages	155
Set permissions on an e-mail message.....	158

Chapter 8 Getting Connected..... 159

8.1 Comm Manager	160
8.2 Ways of Connecting to the Internet.....	161
8.3 Wi-Fi	161
Connect to T-Mobile HotSpot.....	161
About UMA.....	165
8.4 GPRS/EDGE	172
8.5 Dial-up and Others.....	173
8.6 Internet Explorer® Mobile.....	175
Browse the Web	175

8.7 Using Your Phone as a Modem (Internet Sharing).....	177
8.8 Bluetooth.....	179
Bluetooth modes.....	179
Bluetooth partnerships.....	180
Connect a Bluetooth hands-free or stereo headset.....	182
Beam information using Bluetooth.....	183
8.9 Windows Live™.....	185
Set up Windows Live™.....	185
The Windows Live™ interface.....	187
8.10 Windows Live™ Messenger.....	188
Launch the messenger and sign in.....	188
Add Windows Live™ contacts.....	189
Send instant messages.....	190
Personalize the messenger.....	191
8.11 Windows Live™ Search.....	192

Chapter 9 Experiencing Multimedia 193

9.1 Camera.....	194
Take a photo or capture a video clip.....	194
Capture modes.....	194
Camera mode icons and indicators.....	196
Quick Settings Menu.....	197
Use zooming.....	198
Quick Send.....	198
The Review screen.....	200
Camera Capture and Advanced Settings.....	201
9.2 Photos & Video Album.....	202

9.3 Windows Media® Player Mobile.....	204
About the controls.....	204
About the screens and menus.....	205
About licenses and protected files	206
Synchronize video and audio files	206
Play media.....	210
Playlists	210
Troubleshooting	211
9.4 Java Applications	212
Install and run MIDlets/MIDlet suite.....	212
Manage MIDlets	214

Chapter 10 Using Other Applications..... 215

10.1 Microsoft® Office Mobile	216
10.2 Microsoft® Office Word Mobile.....	216
View documents.....	216
Edit and send documents	217
10.3 Microsoft® Office Excel® Mobile	218
View worksheets.....	218
Edit and send worksheets	220
10.4 Microsoft® Office PowerPoint® Mobile	222
10.5 Microsoft® Office OneNote® Mobile	224
10.6 Adobe® Reader® LE	225
10.7 Speed Dial.....	225
10.8 Voice Command.....	227

Appendix.....	231
A.1 Specifications.....	232
A.2 Regulatory Notices	235
Index.....	243

Welcome to T-Mobile®

Introduction

T-Mobile Services and Applications

Activating Service

Introduction

This User Manual provides you with detailed instructions on using your T-Mobile Shadow™ and services.

You will also find information from the following sources:

T-Mobile Customer Care

The T-Mobile Customer Care team offers responsive, knowledgeable customer support 24 hours a day, seven days a week. In addition, you can always access free online help for your device at support.t-mobile.com, and for your account at my.t-mobile.com.

- General Questions

Our Customer Care team can assist in many things including service activation, billing, GSM/GPRS coverage information, voicemail, and feature additions. Just dial 1-800-937-8997 or 611 on your device.

Windows Mobile® Web site

(<http://www.microsoft.com/windowsmobile>)

T-Mobile Services and Applications

With your new T-Mobile Shadow and T-Mobile's service package, you get the freedom of excellent voice and broadband connectivity in many locations nationwide.

Important By using T-Mobile services, you acknowledge that you have read, understood and agreed to be bound by each of the terms and conditions of the Service Agreement.

When you activate service with T-Mobile, the following features and services are available to you:

Voice/Phone

- Local calling and nationwide long distance calling
- International calling *
- Caller ID
- Call waiting and call hold **
- Conference calling **
- Call forwarding **

* **Note** Log on to my.t-mobile.com to set up international calling. See www.t-mobile.com/international/ for rate and other information on international services.

- ** **Notes**
- Airtime rates apply for all completed calls. Calls that are forwarded to numbers outside the local calling area are charged long distance rates. These features may include charges for multiple calls.
 - Calls made in any T-Mobile coverage area, including 911 calls, may not always be completed due to factors such as weather conditions, terrain, foliage, building structures, and equipment limitations.
 - You can use your device to access 911 Emergency Service while you are on a call. You can access 911 even if you DO NOT have a SIM card in the device. All 911 calls are FREE.

Voice mail

Your T-Mobile Shadow has been programmed to forward calls when your line is busy or when you are not available. T-Mobile's voicemail system offers your caller the option to record a voice message that you can play back at your convenience or to send a numeric page to your device.

Note Airtime charges apply to receipt and retrieval of voicemail messages.

E-mail

Set Up E-mail () provides you unlimited access to your work and personal e-mail. Instantly access your e-mail from AOL® AIM®, Yahoo!®, Microsoft® Exchange and many more, including any POP3 or IMAP4 e-mail server.

For more information about setting up and using e-mail, see Chapter 6 and 7.

Messaging services

Text Messaging (SMS)

Text messaging allows you to send, receive, and reply to short text messages using your device. Messages may be sent to and from mobile devices that support text messaging. You may be charged for using text messaging depending on your rate plan. Visit www.t-mobile.com or a T-Mobile store for domestic and international text messaging rates.

For more information about sending text messages, see Chapter 6.

Picture Messaging

Picture Messaging allows you to send and receive picture messages. You can take pictures and videos using the device's integrated camera and send them to family and friends. You may be charged for using Picture Messaging depending on your rate plan. Visit www.t-mobile.com or a T-Mobile store for domestic and international Picture Messaging rates, and information on phones and participating services capable of receiving Picture Messages.

For more information about sending Picture Messages, see Chapter 6.

Instant Messaging (IM)

Your device comes with instant messaging (IM) applications pre-installed for your convenience. Your normal screen name and password work just as they would on any computer connected to the Internet. You may be charged for using instant messaging depending on your rate plan.

Visit www.t-mobile.com or a T-Mobile store for domestic and international instant messaging rates.

For more information about using Instant Messaging, see Chapter 6.

T-Mobile myFaves®

T-Mobile myFaves helps you stay connected to the people who matter most in your life. Simply choose any five U.S. phone numbers* you call most often, on any network, and have them displayed on your phone's main screen. To subscribe, go to www.t-mobile.com.

When you subscribe to the service, you can take advantage of the following:

- Unlimited nationwide calling to any five numbers, on any network (even landlines)
- One-touch calling, text messaging**, and photo sharing**
- No domestic roaming or domestic long-distance charges
- Personalize contacts with favorite pictures** or downloadable icons**

* Excluding 411, voicemail, toll-free, 900, calling card, customers' own numbers, numbers accessing 500 or more lines, conference bridges, and chat lines – other restrictions may apply.

** Separate purchase/download charges may apply. Separate charges apply to send/receive domestic/international text and picture messages.

For more information, see "T-Mobile myFaves®" in Chapter 5.

You can also visit www.t-mobile.com for the latest information.

T-Mobile HotSpot

T-Mobile HotSpot gives you wireless access to the Internet over the T-Mobile Wi-Fi network in locations across the U.S., such as airports, hotels, airline clubs, coffeehouses, bookstores, universities, and more. To access T-Mobile HotSpot for data services including email and web browsing, you must add a data plan to your account. A T-Mobile HotSpot plan is not needed for Wi-Fi calling. Inform your T-Mobile Activations representative that you want to add a data plan when activating your T-Mobile service. Visit www.t-mobile.com or a T-Mobile store for plan information.

For more information about T-Mobile HotSpot, see “Connect to T-Mobile HotSpot” in Chapter 8.

Mobile Backup

This is a free service that lets you view, back up, and manage your contact, tasks, and calendar items on www.t-mobile.com. See Chapter 5 for details.

International Service

You can access the Internet and make calls using your device while abroad. To take advantage of this service, visit my.t-mobile.com or contact Customer Care at **1-800-937-8997** to activate international calling features. Inform the representative that you want to use T-Mobile service (voice and data) internationally. The representative will add the service to your account at no charge. For more information on international service, visit www.t-mobile.com/international/.

Note Additional fees may apply. Countries that support international wireless Internet roaming may not be the same as countries that support international voice roaming. Please refer to www.t-mobile.com/international/ for information on world-class Internet service.

Activating Service

If your service has not been activated, then follow the steps in this section to activate. The

T-Mobile Activations representative will set up your service and assign your mobile number. It takes about 20 minutes to activate voice service and may take up to 24 hours to activate data service. Business and government accounts may take additional time to activate voice and data service. By activating service, you acknowledge that you have read and agreed to the Terms and Conditions of the Service Agreement.

1. Have your service agreement and the following information ready for your Activations representative:
 - Name, home address, home phone, preferred billing address
 - Note** For business and government accounts, your Activations representative will also require your physical address, company name or government agency name, and the tax ID.
 - Social Security number, current driver's license number, and date of birth for credit-check purposes
 - Model number of your device (T-Mobile Shadow)
 - SIM serial number (on the back of the SIM card)
 - IMEI number (on the label under the battery)
 - Agent code (on your service agreement)
 - Your choice of T-Mobile rate plans and services
2. Call Customer Care at 1-800-937-8997 from a landline phone.

Chapter 1

Getting Started

- 1.1 Getting to Know Your Phone and Its Accessories**
 - 1.2 Inserting the SIM Card**
 - 1.3 Installing a microSD Card**
 - 1.4 Charging the Battery**
 - 1.5 Turning On the Phone**
- 1.6 Using the Headset / Charging Cable**
 - 1.7 The Home Screen**
- 1.8 Programs On Your Phone**
 - 1.9 Using the Start Menu**
 - 1.10 Using the Quick List**
 - 1.11 Entering Information**
 - 1.12 Battery Information**
 - 1.13 Shortcut Key**
 - 1.14 Status Indicators**

1.1 Getting to Know Your Phone and Its Accessories

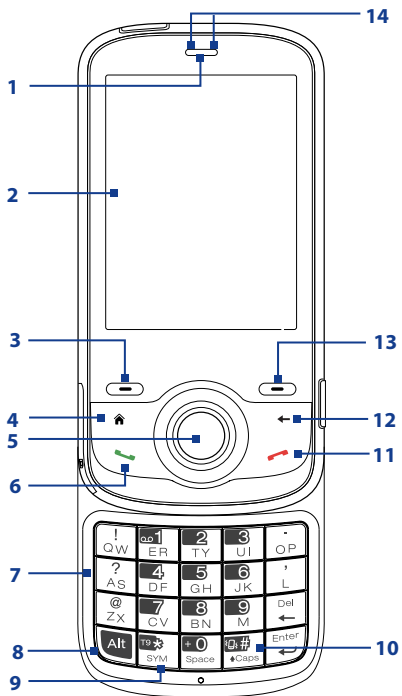



Item	Function
1. Receiver	Listen to a phone call.
2. Display Screen	Touch 320 x 240 QVGA LCD with white LED back light
3. Left SOFT KEY	Press to perform the command shown in the label above the button.
4. HOME	Press to go to the Home Screen.
5. NAVIGATION WHEEL/CENTER SELECT Key	Use to scroll left, right, up, or down. You can either turn the wheel or press the wheel to scroll through items or screens. Press the center to use as the CENTER SELECT Key. The NAVIGATION WHEEL also features an LED indicator for certain phone alerts. For more information, see "Navigation Wheel Alerts" in this chapter.
6. SEND	Press to dial a phone number, answer a call, switch to another call, or put a call on hold. Press and hold to activate/deactivate speakerphone mode.
7. 20-key QWERTY Keyboard	Slide up the front panel of the phone to reveal the keyboard. Use to dial phone numbers, enter information, and write messages.
8. Alt Key	Press once to type symbols and enter numbers in text fields. Press twice for continuous symbol or number entries.
9. Symbol Key	Press to open the Symbol pad.
10. Caps Key	Press to type a single capital letter; press twice to type in all caps.
11. END	Press to end a call.
12. BACK	Press to go to the previous screen, or backspace over characters.
13. Right SOFT KEY	Press to perform the command shown in the label above the button.
14. LED Indicators	The left LED indicators (green/red/amber) notify you of the battery and network status of your phone, while the right indicators (blue/green) notify you of Bluetooth and Wi-Fi connectivity status. For more information, see "LED indicator lights" in this chapter.

32 Getting Started

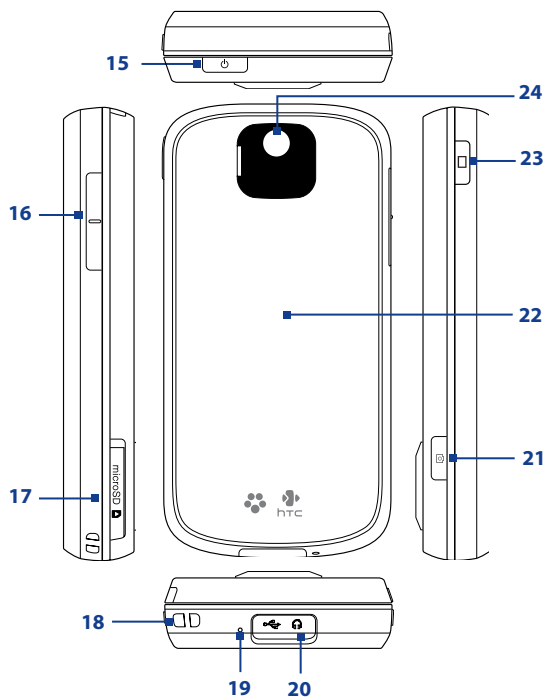

Item	Function
15. POWER	Press and hold for about 3 seconds to turn the phone on or off.
16. VOLUME CONTROL	Adjust the volume of your phone. Press the Up-arrow button to increase the volume; press the Down-arrow button to decrease the volume.
17. microSD™ card slot	Remove the cover to insert a microSD™ card.
18. Lanyard/Strap Holder	Attach a strap to carry the device.
19. Microphone	Speak into the microphone when receiving or making a phone call or during voice recording.
20. Sync Connector/ Earphone Jack	Use for synchronizing data or recharging the battery. Remove the cover to connect the earphone to listen to audio media or use the phone's hands-free kit.
21. CAMERA	Press to open the Camera program.
22. Back Cover	Remove to insert the battery and SIM card.
23. SHORTCUT KEY	Press or press and hold to open phone applications. By default, briefly pressing this button calls up the Messaging screen; pressing and holding this button activates Wi-Fi Quick Connect. See "Shortcut Key" in this chapter for more details.
24. Camera Lens	

Navigation Wheel Light Alerts

Phone Alert	Light Behavior
Phone ringing	The light flashes on with 3 quick pulses and then fades off.
New E-mail	Breathing (the light cycles between fading on and fading off).
New Text Message	Long Flashing (the light flashes on every three seconds, repeating three times).

Phone Alert	Light Behavior
New Voice Message	Short Flashing (the light flashes on every second, repeating three times).
Power On	The light slowly fades on and then slowly fades off.

LED indicator lights

Various colors that might display in the two LED Indicators are summarized here.

Left LED	Status
Solid green	Battery is fully charged.
Blank	Battery case is empty, no SIM card inserted or phone is off.
Solid amber	Battery is charging or the phone is using ActiveSync to synchronize with a PC.
Solid red	Battery is not installed or battery is over-discharged.
Flashing green	Connected to the network.
Flashing red	Battery very low (less than 10%).
Flashing amber	Battery temperature is hotter or colder than the functional limits of 32 to 118 degrees Fahrenheit, and has stopped charging.
Amber/Green LED off	Battery fault. The "Battery Fault" indicator () is displayed. In this case, the flashing green LED can be recovered by unplugging the AC adapter.

Right LED	Status
Flashing blue	Bluetooth mode set to "On" or "Visible" mode.
Flashing green	Wi-Fi is turned on.

Accessories

The following accessories and items are provided with the T-Mobile Shadow:

- Battery
- AC adapter
- Stereo headset
- Headset / charging cable
- USB sync cable
- Pouch

1.2 Inserting the SIM Card

Your SIM (Subscriber Identity Module) card is given to you by T-Mobile and contains your basic subscriber information, such as your phone number and your address book.

Before you begin, ensure that the phone is turned off.

Open the cover and remove the battery

1. Hold the phone in one hand facing down in the palm of your hand, and then with your other hand, slide the back cover upward to remove it.
2. Remove the battery by lifting the black strip from the bottom end.

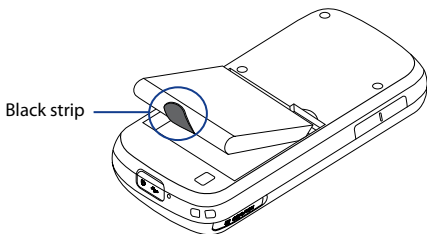
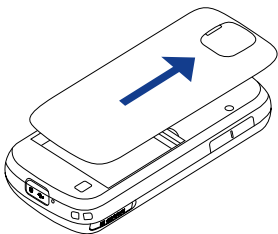

Insert the SIM card

Insert the SIM card into the slot at the top-right corner (underneath the metal tab) with its gold-plated contacts facing down. Push the SIM card all the way in until the SIM card locks into place.

After inserting the SIM card, push the metal tab upwards.

Note Ensure that the metal tab is completely seated before inserting the battery.

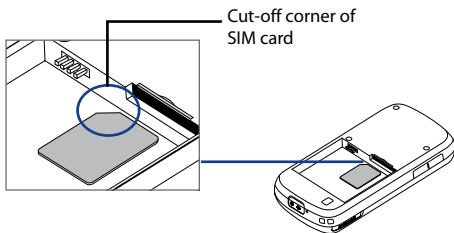

Remove the SIM card

1. Pull the metal tab out (the SIM card will slide down along with metal tab).
2. Push the metal tab in and then slide out the SIM card.

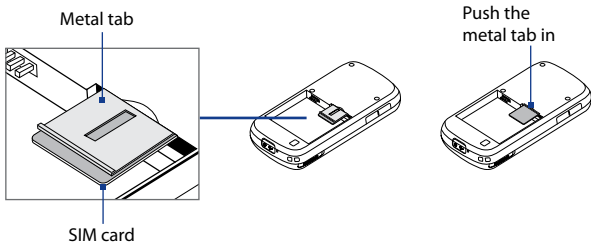

Replace the battery

Make sure the metal tab for the SIM card is pushed in all the way in before inserting the battery.

1. Align the exposed metal contacts on the edge of the battery with the prongs in the body of the phone then gently push the top of the battery into place.
2. Press the bottom part of the battery into place.

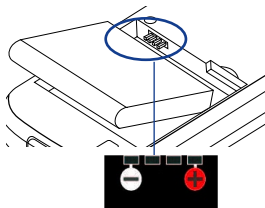

1.3 Installing a microSD Card

You can install a microSD™ (Secure Digital) card on your phone to have an alternative storage place for your images, video, music, and other phone data.

Note A microSD card is not shipped with the phone.

To install the microSD card

1. Open the cover on the right side of the phone.
2. Insert the microSD card into the slot with its gold contacts facing up.

To remove, press the microSD card to pop it out of the slot.

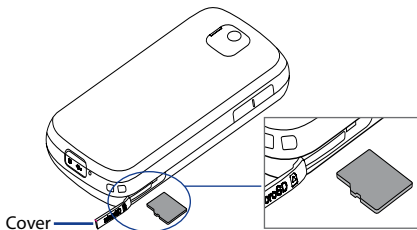

1.4 Charging the Battery

You can charge the battery by using either the AC adapter or the USB cable that came in the box.

Note You should only use the AC adapter and USB cable that came in the box to charge the battery of the phone.

Use the AC adapter

1. Plug the AC adapter plug in to an electrical outlet.
2. Insert the USB end of the AC adapter to the sync connector port at the bottom of the phone. The battery is fully charged after about 3 hours.

Use the USB cable

1. Insert the big USB plug end to a USB port on your computer.
2. Insert the small USB plug end to the sync connector port at the bottom of the phone.

Note When connecting the AC adapter or the USB cable to the phone, make sure that you push the end of the cable that connects to the phone all the way in.

1.5 Turning On the Phone

Turn on the phone by pressing the POWER button on top of the phone for about 3 seconds.

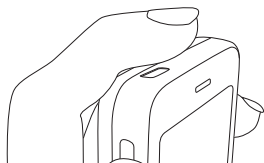

The first time you start up your device, a **Welcome** screen appears to help you get started using the phone. Select one of the buttons to play an introductory video, get help on initial settings, or to start using the phone right away.

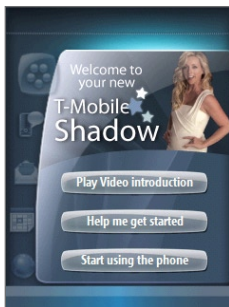

1.6 Using the Headset / Charging Cable

Your device comes with an headset / charging cable that enables you to use a stereo headset to listen to music while the device is connected to an AC adapter or the USB sync cable. You can use the USB stereo headset that comes with your device, or connect a headset with either a 2.5 mm or 3.5 mm jack.

To connect the headset / charging cable

1. Connect the USB connector of the headset / charging cable to the sync connector on your device.
2. Connect the USB connector of the AC adapter / USB sync cable to the headset / charging cable.
3. Plug the AC adapter into an electrical outlet or the USB sync cable to your computer.
4. Connect a stereo headset to the headset / charging cable to listen to music.

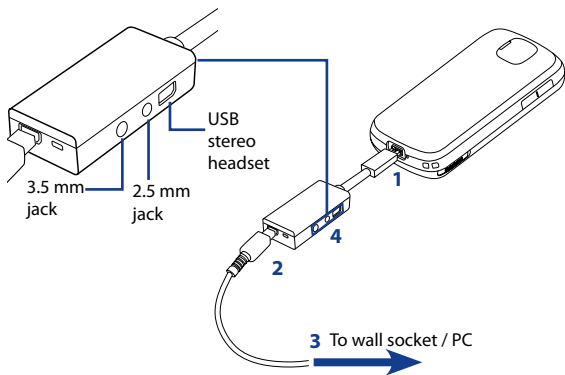

1.7 The Home Screen

The Home screen displays important information, such as upcoming appointments, status indicators, current date and time, battery level, and profile.

The Home screen gives you quick access to various applications and settings that you frequently use on your phone. Press the **NAVIGATION WHEEL** up/down to go through the icons on the Shortcut Bar (left panel) of the screen. When an icon is selected, you can then scroll the **NAVIGATION WHEEL** clockwise/counterclockwise or press **NAVIGATION WHEEL** left/right to go through the available items of that particular Shortcut Bar icon. Open the item or application by pressing **CENTER SELECT**.

Tip To access the Home screen from anywhere, press the **HOME** key on the phone.

1. Select to display all program icons.
2. Shortcut Bar. See "Shortcut Bar" in this chapter for details.
3. Displays the network carrier name the phone is using and the time.
4. Displays notifications, such as missed calls or new messages.
5. Displays the T-Mobile HotSpot status. See Chapter 8 for details.
6. Displays Wi-Fi status.
7. Displays the power status.
8. Displays the network signal strength. When UMA is available, displays magenta UMA signal bars. See "About UMA" in Chapter 8.
9. Depending on the Shortcut Bar icon selected, this displays the wallpaper image, an image of an item associated with the Shortcut Bar icon, T-Mobile® myFavesSM contacts, or photos in your phone.
10. Depending on the Shortcut Bar icon selected, this displays the myFaves contact name, names of the item associated with the Shortcut Bar icon, messages, notifications, appointments, or music track name.
11. Opens the program, setting, or shortcut associated with the selected Shortcut Bar item.

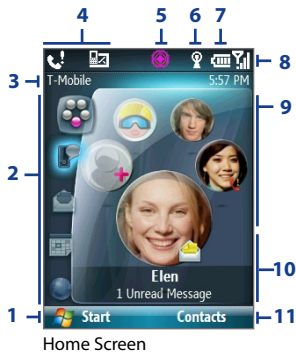

Shortcut Bar

The Shortcut Bar lets you quickly access various information and applications on your phone.

myFavesSM

Access your myFavesSM contacts right on the Home screen. See Chapter 5 for details.

Pressing the **HOME** key wherever on the Home screen will bring you to your myFaves.

If you do not subscribe to the myFaves service, a different screen appears.



with myFaves



without myFaves

Notifications

Gives you quick access to view missed calls and new messages. This icon glows when there is a new notification.

Scroll the **NAVIGATION WHEEL** clockwise or counterclockwise to go through items and then press **CENTER SELECT** to open a specific notification.



Message Center

Gives you quick access to all of your configured messaging account inboxes. You can also create and send an audio postcard and create a new e-mail account here.

To quickly create a new message or audio postcard, scroll to the messaging account or **Audio Postcards** and then select **Compose**.



Appointments

Lets you see your upcoming appointments for the day or set a new appointment. If you have more than one appointment for the day, use the **NAVIGATION WHEEL** to scroll through the appointments.

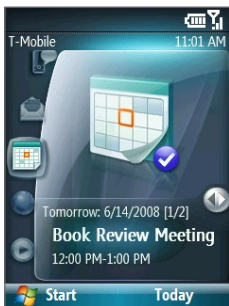

Internet

Quickly open your browser to surf the Internet, access t-zones to purchase ring tones and wallpapers, and more. You can also access your T-Mobile account here.

You can quickly go to the t-zones page to purchase wallpapers or ringtones by using the **NAVIGATION WHEEL** to select **Browse Wallpaper** or **Browse Hi-Fi Ringers**.



Media

Start your music player straight from the Home screen. Use the **NAVIGATION WHEEL** to scroll through the music in your phone and then press **CENTER SELECT** to play and pause music.

While playing back a song, select **Windows Media** to open Windows Media Player to display more playback controls.



Photos

Browse the photos in your phone by using the **NAVIGATION WHEEL**. Press **CENTER SELECT** to view a photo using the picture viewer.

While viewing the photo, you can quickly send the image using any one of your messaging accounts. Select **Menu > Send** or **Menu > Send as Audio Postcard**.



Settings











Lets you quickly access the Comm Manager and Task Manager, change your profile, wallpaper, or ring tone, and check the phone's battery power.













Select **All Settings** to show all available settings.























1.8 Programs On Your Phone







The following table lists icons of the programs that are already installed on your phone or are available on the Getting Started Disc that came with your phone.

Icon	Program	Description
	Applications	
	ActiveSync	Synchronize information between your phone and PC.
	Adobe Reader LE	View PDF files.
	Calculator	Do basic arithmetic and calculations.
	Clock & Alarm	Set the date and time and alarms.
	File Explorer	Organize and manage files and folders.
	Java Applications	Download and install Java-based applications, such as games and tools.
	Speed Dial	Create speed dial entries for dialing frequently called phone numbers or for opening frequently accessed programs.
	Tasks	Keep track of your tasks.
	Voice Command	Call contacts, open applications, play back music, and get calendar information just by using your voice.
	Voice Recorder	Create short voice recordings.

Icon	Program	Description
	Calendar	Keep track of your appointments, and create meeting requests.
	Call History	Keep track of all phone calls made, received, and missed.
	Camera	Capture photos in various modes.
	Comm Manager	Manage your phone's connections (including Wi-Fi, GPRS/EDGE, and Bluetooth), turn the phone on or off, enable or disable the Direct Push function, and more.
	Contacts	Keep track of contact information.
	Device Management	 Clear Storage Clear the memory and restore the phone back to factory default settings.  Internet Sharing Turn your phone into an external modem for your computer.  Mobile Backup Synchronize and back up contacts with the T-Mobile Web site.  SIM Manager Manage the contacts that are stored on your SIM card.
	Games	Play two games, Bubble Breaker and Solitaire, that come with your phone.
	Help	Learn how to use some of the features of your device, troubleshoot problems, check your account, and more.

Icon	Program	Description
	Internet Applications	 Handango InHand Browse, purchase, and install applications for your phone.
		 Live Search Search for locations that suit your interests, plan a driving route, check map, and see traffic conditions.
		 Windows Live Use this mobile version of Windows Live™ to find information on the Web. It lets you sign in to your Windows Live account so that you can access your Live Mail messages and send/receive instant messages in Live Messenger.
	Internet Explorer	Browse Web and WAP sites as well as download new programs and files from the Internet.
	Instant Messaging	Access various Instant Messaging programs such as AIM®, ICQ®, and Yahoo®, and use Messenger , the mobile version of Windows Live Messenger.
	Messaging	Send and receive e-mails, text messages, and picture messages.
	myFaves Settings	Use T-Mobile® myFaves SM to stay connected to the people who matter most in your life. Simply choose any five U.S. phone numbers you call most often, on any network, and have them displayed on your phone's Home screen.
	Office Mobile	Use the complete suite of Microsoft® Office applications for your phone.
		 Excel Mobile View and edit Microsoft® Excel® worksheets.
		 PowerPoint Mobile View Microsoft® PowerPoint® presentation files.
		 Word Mobile View and edit Microsoft® Word documents and text files.
	OneNote Mobile Create OneNote files on your phone and then synchronize them with your PC.	

Icon	Program	Description
	Photo & Video Album	View photos that you captured using the phone's camera.
	Send Audio Postcard	Quickly add a voice recording to captured photos and then send them to family and friends.
	Settings	Personalize your phone to suit the way you use it.
	Set Up E-Mail	Enjoy unlimited access to your work and personal email. Instantly access your e-mail from AOL® AIM®, Yahoo!®, Microsoft® Exchange and many more, including any POP3 or IMAP4 e-mail server.
	Task Manager	Close running programs and check available memory on your phone.
	t-zones	Visit T-Mobile's t-zones Web site to purchase ring tones, wallpaper, or games to personalize your phone. You can also manage your accounts and access other helpful information. You can quickly go to the t-zones page to purchase wallpapers or ringtones by scrolling down to  on the Shortcuts bar and selecting Browse Wallpaper or Browse Hi-Fi Ringers .
	Video Recorder	Capture video clips in various modes and duration

Icon	Program	Description
	WiFi	 Comm Manager Manage your phone's connections (including Wi-Fi, GPRS/EDGE, and Bluetooth), turn the phone on or off, enable or disable the Direct Push function, and more.  HotSpot Settings Enter your HotSpot username and password to automatically connect when you are in a T-Mobile HotSpot. You need to have a T-Mobile HotSpot account to access the T-Mobile HotSpot wireless network for data service like email and web browsing. An account is not needed for Wi-Fi calling.  HotSpot Status See if you are in the T-Mobile HotSpot coverage area. Use this program to log off from T-Mobile HotSpot.  Wi-Fi Setup Provides information on Wi-Fi calling, connecting to Wi-Fi networks, switching between Wi-Fi and GSM, and more.
	Windows Media Player	Play back video and audio files.

1.9 Using the Start Menu

The Start menu is located at the bottom-left corner of the Home screen and displays various program icons that are spread across one or more screens.

To see the available programs in the Start menu

On the Home screen, select **Start**. To see more programs, select **More** or use the **NAVIGATION WHEEL**.

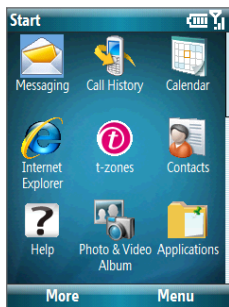

1.10 Using the Quick List

The Quick List offers convenient access to a list of functions, such as locking your phone, opening Comm Manager, and choosing a different profile. For more information about profiles, see Chapter 4.

To access the Quick List

1. Press and hold the **HOME** button.
2. Scroll through the list to select the desired option. Then, do either of the following:
 - Choose **Select**.
 - Press **CENTER SELECT**.

Tip You can also press the corresponding number on the 20-key QWERTY keyboard to select an option.

3. To exit the Quick List at any time, select **Cancel**.

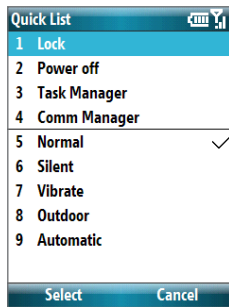

1.11 Entering Information

You can enter text, numbers, and symbols by using the 20-key QWERTY keyboard. When you select a field that requires entering text or numbers, the phone automatically selects the appropriate input mode. The status indicator on the top-right side of the display screen shows the input mode that you are currently using.

Input modes

abc	Lowercase text input	12#	Numeric or symbol (labeled in brown color) input	T9	T9 text input mode, uppercase
ABC	Uppercase text input, caps lock	12#	Numeric or symbol (labeled in blue color) input, locked	T9	T9 text input mode, caps lock
ABC	Uppercase text input			t9	T9 text input mode, lowercase

To change the input method, press and hold  and select the input method you want to use on the menu.

- To use T9 predictive text mode, select **Predictive Text > On**.
- To use multipress (abc) mode, select **Predictive Text > Off**.



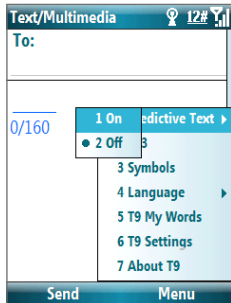





Note The menu only opens when text input is possible. Pressing and holding the  key any other time will lock the phone.



The 20-key QWERTY keyboard

To reveal the 20-key QWERTY keyboard, slide up the front panel of the phone.

You can do the following with the 20-key QWERTY keyboard:

- To use a single uppercase letter, press  and then press the corresponding key.
- To use all uppercase letters, press  twice. To change back to all lowercase letters, press  again.
- To enter a number or symbol in the shaded area above the letters, press  and then press the corresponding key.
- Press  to open the Symbol pad. Press and hold  to open the input menu.
- Press and hold  to lock the phone (when text input is not possible).
- While on the Home screen, press and hold  to toggle between Ringer and Vibrate modes.
- Press and hold  to access your voicemail.

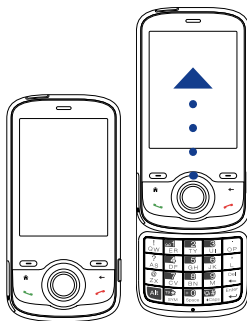

Slide up the front panel

Multipress mode

In Multipress mode, you enter a character by pressing the key on which the character appears.

To switch to Multipress mode

1. While on a text field, press and hold the  key.
2. If Predictive Text is enabled, select **Predictive Text > Off**.

To enter text in Multipress mode

- To enter the first character on the numeric key, press once. To enter the second character on the numeric key, press twice, and so on.
- To enter characters that are on the same key, wait for the line under the character to disappear before you press the key again.

To change the Multipress time out

You can change the length of time to pause between keypresses on the same numeric key.

1. On the Home screen, select **Start > Settings > Accessibility**.
2. In **Multipress time out**, choose the length of the pause between keypresses and select **Done**.

T9 mode

To form a word in T9 mode, press the keys that contain the letters you want. As you enter letters, T9 analyzes your keypresses and attempts to complete the word. T9 also tries to predict your next word based on previous sentences you have typed.

To switch to T9 mode

1. While on a text field, press and hold the  key.
2. If Predictive Text is disabled, select **Predictive Text > On**.

To add custom words to the T9 My Words list

Save words that you often use but are not in the English dictionary into the T9 My Words list.

Words that you add into the T9 My Words list will appear in the predicted word list.

1. While on a text field, press and hold the  key.
2. On the menu, select **T9 My Words > Add**.
3. In the Add/Edit Word box, enter the word and select **Done**.

To edit or delete words in the T9 My Words list, select **Menu** and then select the appropriate command in the menu.

To set T9 settings

Press and hold  and on the menu, choose **T9 Settings**. In the screen, choose the options you want and select **Done**.

Note You must set **Predictive Text** to **On** before you can choose **T9 Settings**.

- Select **Spell Correction** to correct typographical errors by selecting from a list of possible words that reflect the characters of the keys you have pressed as well as characters of nearby keys.
- Select **Auto-Append** to automatically add your constructed words that are not in the dictionary to the beginning of the predicted word list.
- Select **Auto-Substitution** to automatically add an apostrophe when you type common contracted words (e.g. dont automatically becomes don't).
- Select **Word Completion** to let you select from a list of possible words based on the keys that you pressed and on the words available in the dictionary.
- Select **Multitap Word Completion** to let you select from a list of possible combinations based on the characters that appear on the keys that you pressed.
- Under **Accept Word Completion**, select whether to press the OK key or the Space key to accept the suggested word.

To type using T9 mode

While typing, words will appear in a list. Use the **NAVIGATION WHEEL** to choose the word you want to insert and press **CENTER SELECT**.

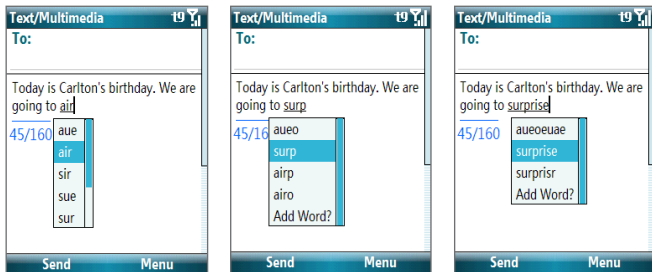

For example, to type “surprise”, just spell out the word “surprise” using the keyboard. You will notice that pressing the keys for the first 3 characters will spell out “air” but after you press the key for the fourth character, the word changes to “surp”. Continue typing until you see the word “surprise” in the suggested words list.

Tip To type in all uppercase letters, press the  key twice.

Numeric mode

If a text box permits a numeric entry only, such as a phone number, the input mode automatically defaults to Numeric mode. However, if you need to enter numbers within a line of text, change to Numeric mode (**123** on the menu) or use the  key.

To enter numbers in text boxes

Press  and then press the numeric key.

Tip To lock the input mode to Numeric mode in a text box, press  twice.

1.12 Battery Information

Battery performance depends on many factors, including T-Mobile's network configuration, signal strength, the temperature of the environment in which you operate your phone, the features and/or settings you select and use, items attached to your phone's connecting ports, and your voice, data, and other program usage patterns.

Battery life estimates (approximations):

- Talk time: GSM/UMA: Up to **8** hours
- Standby time: GSM: Up to **160** hours
UMA: Up to **100** hours
- Playing WMV: Up to **8** hours
- Playing WMA: Up to **12** hours

WARNING! To reduce risk of fire or burns:

- Do not attempt to open, disassemble, or service the battery pack.
- Do not crush, puncture, short external contacts, or dispose of in fire or water.
- Do not expose to temperatures above 140°F.
- Replace only with the battery pack designated for this product.
- Recycle or dispose of used battery as stipulated by local regulation.

To check and optimize battery power

On the Home screen, scroll down to  on the Shortcut Bar, then select **Manage Battery**. On the **Power Management** screen, adjust the backlight, display, and light sensor settings.

To manage low battery

When the low-battery warning appears, do the following:

1. Immediately save your current data.
2. Synchronize with your PC or use the AC adapter to charge the battery.
3. Turn off your phone. Turn it back on only when you need to use it.

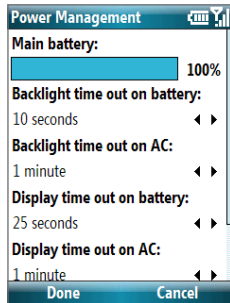

1.13 Shortcut Key













The **SHORTCUT KEY** on the right side of the phone can be configured to open 2 applications that you set. By default, briefly pressing the **SHORTCUT KEY** calls up a message screen (afterwards, it opens the Messaging program); pressing and holding the **SHORTCUT KEY** opens Quick Connect. See “To quickly connect to the Internet” in Chapter 8 for more information about Quick Connect.























To customize Shortcut Key settings

1. Select **Start > Settings > Shortcut Key**.
2. In **Short press**, select the application to open when you briefly press the **SHORTCUT KEY**.
3. In **Press and hold**, select the application to open when you press and hold the **SHORTCUT KEY**.
4. Select **Done**.

1.14 Status Indicators

The following table lists common status indicators and their meanings.

Icon	Description
	T-Mobile HotSpot in use
	T-Mobile HotSpot detected, user is not logged in
	Wi-Fi is on, but phone not connected to a wireless network
	Wi-Fi connected
	Connecting to wireless network
	Synchronizing via Wi-Fi
	Battery level
	Low battery
	Very low battery
	Battery charging
	No battery or battery fault
abc	Lowercase text input
ABC	Uppercase text input, caps lock
ABC	Uppercase text input
12#	Numeric or symbol input (labeled in blue color), locked
12#	Numeric or symbol input (labeled in brown color)
t9	T9 text input mode, lowercase
T9	T9 text input mode, uppercase
T9	T9 text input mode, caps lock
	EDGE in use

Icon	Description
	GPRS in use
	New e-mail or text message (SMS, Short Message Service)
	New instant message from Live Messenger
	Signal strength
	Radio connected or no signal
	Radio off
	UMA in use
	UMA phone call in progress
	Vibrate call alert
	Ringer off
	Speakerphone on
	Voice call in progress
	Data call in progress
	Calls forwarded
	Call on hold
	Missed call
	Dialing while no SIM card is inserted
	No SIM card installed
	SIM card with fault
	Microphone muted
	Bluetooth
	Bluetooth headset connected

Chapter 2

Using Phone Features

2.1 Using the Phone

2.2 Making a Call

2.3 Receiving a Call

2.4 In-Call Options

2.5 Additional Dialing Information

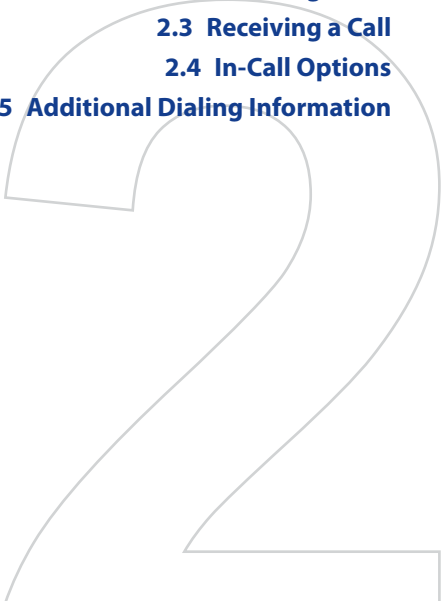

2.1 Using the Phone

You can use your phone to make, receive, and keep track of voice calls, and send text messages (SMS, Short Message Service) and Multimedia Messages (MMS, Multimedia Messaging Service). You can also dial a phone number directly from Contacts, and easily copy SIM contacts to Contacts on the phone.

When connected to a Wi-Fi network, you can use Unlicensed Mobile Access (UMA) technology to make and receive calls. UMA technology also lets you switch between the T-Mobile cellular network and Wi-Fi network seamlessly when you are using your phone. To learn how to connect to a Wi-Fi network, see Chapter 8. For more information about the UMA features of the phone, please contact T-Mobile.

The Phone screen

From the Phone screen, you can open, call, or find a contact, and even save a new number in Contacts. To access the Phone screen, do any of the following:

- Open the keyboard and directly enter the phone number by pressing numeric keys on the keyboard.
- Press  (only when myFaves is minimized or turned off).

Set ring tones

You can choose how to be notified for incoming calls, reminders, new messages, alarms, and more.

To set a ring tone for incoming calls

1. On the Home screen, scroll down to  on the Shortcut Bar, then select **Change Ringtone**.
2. In the **Ring tone** list, select a ring tone.
3. Select **Done**.

If you select **Vibrate**, the sound is muted and the phone will vibrate when you receive a call. The **Vibrate** icon (📞) appears in the title bar. Selecting **None** in the Ring tone list mutes the phone. For more information about sounds, see “Choose how to be notified about events or actions” in Chapter 4.

Note To adjust the earpiece volume during a call, use the **VOLUME BUTTONS** on the side of the phone.

2.2 Making a Call

With your phone, you can make calls from the Home screen, the Phone screen, from Contacts, Speed Dial, Call History, or SIM Contacts (contacts stored on your SIM card). You can choose to dial by name or number.

Make a call from the Home screen

- Enter the phone number or name of the contact on the keyboard and then press .
- Press the **BACK** button or **DEL** key if you need to backspace.

Tip You will notice that when you press a key on the keyboard, a list of names and numbers is displayed as your phone searches Contacts, Call History, Speed Dial, and your SIM card to find a matching name or number. For example, when you press a key such as 5, names that begin with **G** and **H** will be displayed as well as phone numbers that start with **5**. The next key you press continues to narrow the search. When you see the name of the person or number that you want to call, select it, and press .



Phone Screen

Make a call from Contacts

1. On the Home screen, select **Contacts**.
2. Select the desired contact and then press .

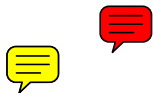

You can also select the desired contact in the contact list, and press **CENTER SELECT** twice (once to view the contact details, and once to dial the associated number).

To specify the number to dial

1. On the Home screen, select **Start** > **Contacts**.
2. Select the contact.
3. Press **NAVIGATION WHEEL** left or right. The letter representing the number changes to m (mobile), w (work), or h (home).

You can also select a contact in the contact list and press **CENTER SELECT** to view details and different numbers associated with the contact. Select a number and press  or press **CENTER SELECT** to dial the number.

- You may also access the contact list by selecting **Contacts** on the Home Screen.
- To view or edit information associated with the selected contact, select **Menu** > **Edit**.

Make a call from Call History

1. On the Home screen, select **Start** > **Call History**.
2. Select a name or number and then press .

In the Call History screen, you can view the call history details of a contact such as date, time of call, and the length of the call by pressing **CENTER SELECT**. Pressing **CENTER SELECT** again dials the associated number.

To customize calls

You can select various options on the Call History screen to customize and filter the calls made, received, or missed.

- To find a name or number in Contacts, select **Menu > Find Contact**.
- To send a text message, select **Menu > Send Text Message**.
- To send an e-mail, select **Menu > E-mail**.
- To find the duration of a call, select **Menu > View Timers**.
- To remove a call or number from Call History, select **Menu > Delete**.
- To remove the list of calls or numbers from **Call History**, select **Menu > Delete List**.
- To save a name or number in Contacts, select **Menu > Save to Contacts**.
- To categorize the call or number into various call types, select **Menu > Filter**.
- To send an Audio Post card, select **Menu > Send Audio Postcard**.

Note You can also save a number in Contacts by selecting **Save on the Call History** screen.

Make a call from Speed Dial

You can make calls using Speed Dial. To learn how to use Speed Dial, see Chapter 10.



Make a call from SIM Manager

1. Select **Start > Device Management > SIM Manager**. Wait for the contents of your SIM card to load.
2. Choose the contact you want to call and select **Menu > Call**.

2.3 Receiving a Call

When you receive a phone call, you have the option to answer, ignore, or reject it. You can also use the **VOLUME BUTTONS** to lower the ringer volume.

To answer, ignore or reject an incoming call

- To answer the call, open the keyboard.
- To answer the call, select **Answer** or press .
- To ignore or reject the call, select **Ignore** or press .

To end a call

- If the keyboard is opened, close the keyboard.
- Press .

You can set answering and ending call options by selecting **Start > Settings > Slide and Key Lock**. Choose the options you want in **Answer calls** and **End calls**.

2.4 In-Call Options

Your phone provides various options for managing multiple calls at the same time. You are notified when you have another incoming call, and you have the choice of ignoring or accepting the call. If you are already on a call and accept the new call, you can choose to switch between the two callers, or set up a conference call between all three parties.

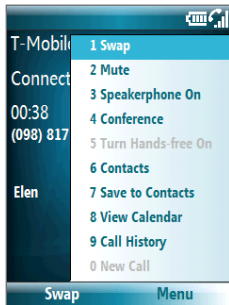

In-Call Options

To answer another call

1. Select **Answer** to take the second call and put the first call on hold.
2. To end the second call and return to the first call, press .

To switch between calls

To switch between two calls, select **Swap**.

To set up a conference call

1. Either put a call on hold and dial a second number, or, answer a second incoming call during a call.
2. Select **Menu > Conference**.

Notes

- If the conference connection is successful, the word “Conference” appears at the top of the screen.
- To add additional persons to your conference call, select **Menu > Hold**, enter the phone number, and then select **Resume** to return to the call.

To turn on and off the Speakerphone

The built-in Speakerphone lets you talk hands-free or lets other people listen to the conversation.

- During a call, select **Menu > Speakerphone On**. The  icon appears at the top of the screen.
- To turn off the Speakerphone during the call, select **Menu > Speakerphone Off**.

Tip Alternatively, the Speakerphone can be toggled on and off by pressing and holding  during the call.

Note It is not recommended to hold your phone against your ear when the Speakerphone is turned on as this might damage your hearing.

To mute a call

You can turn off the microphone during a call, so that you can hear the caller but the caller cannot hear you.



Press the left **SOFT KEY** to select **Mute**. When the microphone is turned off, the  icon appears on the screen. Press the left **SOFT KEY** to select **Unmute** to turn on the microphone again.

2.5 Additional Dialing Information

Make an emergency call

Dial the emergency number (911) and then press .

Make an international call

1. Press and hold the  key on the keyboard until  appears.
2. Enter the full phone number and then press .

For example: +(1)(909)(22222222) (country code) + (area code) + (phone number).

Insert a pause or long pause in a dialing sequence

Some international calls or phone numbers require a pause or long pause in the dialing sequence for the call to process successfully.

1. On the Home screen, select **Start > Contacts**.
2. Select the contact and press **CENTER SELECT** to open the contact card.
3. Select **Menu > Edit**.
4. Position the cursor on the phone number where you want to insert a pause.
5. Select **Menu > Insert Pause** or **Insert Wait**.

The letter “p” (Insert Pause) or “w” (Insert Wait) will appear in the number sequence to indicate where the pause or long pause will occur.

Note Long pause is not available for contacts stored on the SIM card.

6. Select **Done**.

Note When you call a number that contains a long pause, you must press  again to continue dialing.

Chapter 3

Synchronizing Information with Your Computer

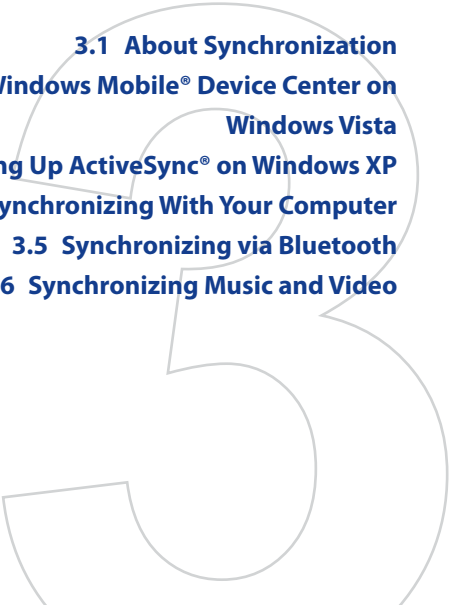
- 3.1 About Synchronization**
 - 3.2 Setting Up Windows Mobile® Device Center on
Windows Vista**
 - 3.3 Setting Up ActiveSync® on Windows XP**
 - 3.4 Synchronizing With Your Computer**
 - 3.5 Synchronizing via Bluetooth**
 - 3.6 Synchronizing Music and Video**
- 

3.1 About Synchronization

You can take information from your computer wherever you go by synchronizing them to your phone. The following types of information can be synchronized:

- **Microsoft® Outlook® information**, which includes Outlook e-mail, contacts, calendar, and tasks
- **Media**, such as pictures, music and video
- **Favorites**, which are the bookmarked links to your favorite Web sites
- **Files**, such as documents and other files

Note You need to use Windows Media Player to synchronize songs that are DRM-protected.

Before you can synchronize, you need to first install the synchronization software to your computer. For information on installing and using the synchronization software on your computer, see “Setting Up Windows Mobile® Device Center on Windows Vista” and “Setting Up ActiveSync® on Windows XP” in this chapter.

Ways to synchronize

After you have installed the synchronization software to your computer, synchronize your phone with your computer by using one of the following:

- Connect and synchronize using the supplied USB sync cable. Upon connecting the sync cable to your phone and your computer, the synchronization process starts automatically.
- Connect and synchronize using Bluetooth. You must first set up a Bluetooth partnership between your phone and your computer before you can synchronize information between them using Bluetooth. For more information about setting up a Bluetooth partnership, see Chapter 8. For information about synchronizing through Bluetooth, see “Synchronizing via Bluetooth” later in this chapter.

Note You can also synchronize Outlook e-mail, contacts, calendar, and tasks on your phone with the Exchange Server at your work. For more information about setting up your phone to synchronize with the Exchange Server, see Chapter 7.

3.2 Setting Up Windows Mobile® Device Center on Windows Vista

Microsoft Windows Mobile® Device Center is the replacement for Microsoft® ActiveSync® on Windows Vista®.

Note Some versions of Windows Vista come with Windows Mobile® Device Center already installed. If Windows Mobile® Device Center is not available on your Windows Vista, you can install it from the Getting Started Disc that came with your phone.

Set up synchronization in Windows Mobile® Device Center

1. Connect your phone to your PC. Windows Mobile® Device Center configures itself and then opens.
2. On the license agreement screen, click **Accept**.
3. On the Windows Mobile® Device Center's Home screen, click **Set up your device**.

Note Choose **Connect without setting up your device** if you only want to transfer media files, check for updates, and explore your phone but not sync Outlook information.

4. Select the items that you want to synchronize and then click **Next**.
5. Enter a device name for your phone and then click **Set Up**.



When you finish the wizard, Windows Mobile® Device Center synchronizes your phone automatically. Notice that Outlook e-mails and other information will appear on your phone after synchronization.

3.3 Setting Up ActiveSync® on Windows XP

The Getting Started Disc that comes with your phone contains Microsoft® ActiveSync® 4.5 or later. Follow the steps below to install and set up ActiveSync® on Windows XP or other compatible Windows systems.

Notes

- You can also download ActiveSync 4.5 from the Microsoft ActiveSync® Web site: <http://www.microsoft.com/windowsmobile/activesync/default.msp>
- From the above Web site, you will find the system requirements for ActiveSync 4.5.

Install ActiveSync®

1. Insert the Getting Started Disc into the disc drive on your PC.
2. Click **Setup and Installation**.
3. Select the **ActiveSync** check box and click **Install**.
4. Read the license terms and click **Accept**.
5. When installation is complete, click **Done**.
6. On the Getting Started with Windows Mobile screen, click **Close**.

Set up synchronization in ActiveSync®

Follow the steps below to set up a synchronization partnership.

1. Connect your phone to your PC. The Synchronization Setup Wizard automatically starts and guides you to create a synchronization relationship. Click **Next** to proceed.
2. To synchronize your phone with your computer, clear the **Synchronize directly with a server running Microsoft Exchange Server** check box and then click **Next**.
3. Select the items that you want to synchronize and then click **Next**.
4. Select or clear the **Allow wireless data connections** check box according to your preference.
5. Click **Finish**.

When you finish the wizard, ActiveSync synchronizes your phone automatically. Notice that Outlook e-mails and other information will appear on your phone after synchronization.

3.4 Synchronizing With Your Computer

Connect your phone to your PC to synchronize the information between your phone and PC. While your phone is connected, Windows Mobile® Device Center or ActiveSync® on your PC automatically synchronizes when you make a change on either the PC or your phone.

Start and stop synchronization

You can also manually start and stop synchronization either from your phone or PC.



From your phone

1. After connecting your phone to your PC, select **Start > Applications > ActiveSync** on your phone.
2. Select **Sync** to start synchronization.



To end synchronization before it completes, select **Stop**.

Note To delete a partnership with one PC completely, select **Menu > Options**, select the computer name, then select **Menu > Delete**.

From Windows Mobile® Device Center

1. Click **Start > All Programs > Windows Mobile Device Center**.
2. Click  at the lower left of the Windows Mobile® Device Center. To end synchronization before it completes, click .

From ActiveSync on your PC

- To manually start synchronization, open ActiveSync on your PC and click .
- To end synchronization before it completes, click .

Change which information is synchronized

You can add or reduce the types of information to synchronize between your phone and PC.

1. Before changing synchronization settings on your phone, disconnect your phone from your PC.
2. On your phone, select **Start > Applications > ActiveSync**.
3. Select **Menu > Options**.
4. Select or clear the items you want to synchronize or not synchronize. If you cannot select a check box, you might have to clear the check box for the same information type elsewhere in the list.
5. To customize settings for an item, select that item and select **Settings**. Settings are not available for all items.

Notes

- The check boxes of the Favorites, Files, Media, and OneNote items are always grayed out in ActiveSync Options on your phone. You can only select or clear these items from Windows Mobile Device Center or ActiveSync on your computer.
- A PC can have sync partnerships with many different Windows Mobile® powered devices, but a device can have sync partnerships with at most two PCs only. To ensure that your phone will synchronize properly with both PCs, set up the second PC using the same synchronization settings you used on the first PC.
- Outlook e-mail can be synchronized with only one computer.

Troubleshoot sync connection problems

When the PC is connected to the Internet or a local network, in some cases, the PC may disconnect the ActiveSync® connection with your phone in favor of the Internet or network connection. If this happens, select **Start > Settings > Connections > USB to PC**, then clear the **Enable advanced network functionality** check box. This makes ActiveSync use a serial USB connection with your phone.

3.5 Synchronizing via Bluetooth

You can connect and synchronize your phone with the PC using Bluetooth.

To synchronize with a computer via Bluetooth

1. Set up the synchronization software (Windows Mobile® Device Center or ActiveSync) on your computer to use a Bluetooth connection. For more information, see the software Help on your computer.
2. On your phone, select **Start > Applications > ActiveSync**.
3. Make sure that Bluetooth on both your phone and the computer are turned on and set to **Visible** mode. For more information, see “Bluetooth” in Chapter 8.
4. Select **Menu > Connect via Bluetooth**.
5. If this is the first time you have connected to this computer via Bluetooth, you must first complete the Bluetooth wizard on your phone and set up a Bluetooth partnership between your phone and the computer. For more information about creating a Bluetooth partnership, see “Bluetooth partnerships” in Chapter 8.

Notes

- To preserve battery power, turn off Bluetooth when not in use.
- To connect and synchronize your phone with a computer via Bluetooth, your computer must have built-in Bluetooth or be installed with a Bluetooth adapter or dongle.

3.6 Synchronizing Music and Video

If you want to carry your music or other digital media along with you while you travel, set up Microsoft® Windows Media® Player on your computer to synchronize music and video with your phone.

Other than selecting the **Media** information type in ActiveSync® for synchronization, all media synchronization settings must be set in Windows Media® Player. Before you can synchronize media, you must do the following:

- Install Windows Media® Player 11 on the PC. (Windows Media® Player 11 works only in Windows XP or later versions.)
- Connect your phone to the PC with a USB cable.
- Set up a sync partnership between the phone and your PC's Windows Media® Player.

Note Use Windows Media® Player 11 to properly transfer digitally protected music files from your computer to your phone. If you do not use Windows Media® Player 11 to synchronize the files, you will not be able to play them on your phone.

For more information about using Windows Media® Player on your phone, see “Windows Media® Player Mobile” in Chapter 9.

Chapter 4

Managing your Phone

- 4.1 Personalizing Your Phone**
- 4.2 Adding and Removing Programs**
- 4.3 Using Task Manager and Managing Memory**
- 4.4 Managing and Backing Up Files**
- 4.5 Protecting Your Phone**
- 4.6 Restarting Your Phone**
- 4.7 Resetting Your Phone**

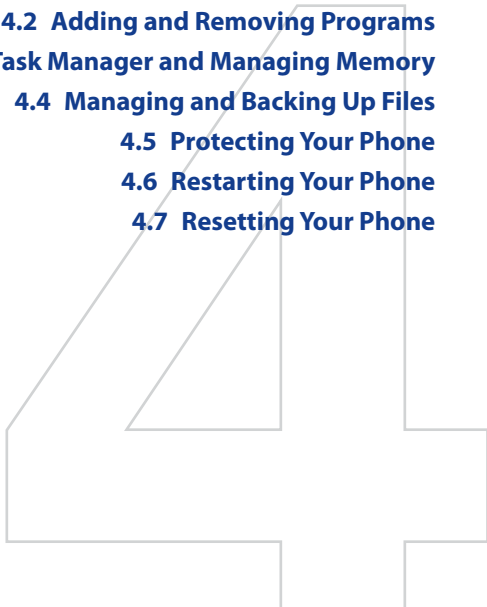

4.1 Personalizing Your Phone

Set up the Home screen

The Home screen is your starting place for most tasks. You can gain access to all features and programs from the Home screen.

To customize the Home screen

1. On the Home screen, select **Start > Settings > Home Screen**.
2. In **Home screen layout**, **Color scheme**, **Background image**, and **Time out**, choose the options you want, and select **Done**.

Tip If you only want to change the background image, you can do it from the Shortcut Bar. On the Home screen, scroll down to  on the Shortcut Bar, and then select **Change Wallpaper**.

To set a picture as the background

1. On the Home screen, select **Start > Photo & Video Album**.
2. Select the picture you want to set as the background. Press **CENTER SELECT** for a larger view of the image.
3. Select **Menu > Set as Home Screen**.

Set date, time, and other regional options

Your phone should already be set up with the regional settings that are appropriate for your locale.

To change regional settings

You can specify the locale, date and time style, as well as number and currency formatting options.

1. On the Home screen, select **Start > Settings > Regional Settings**.
2. In **Locale**, select the locale for different regions. The Locale option automatically changes the format of the remaining options (such as date, time, and currency) according to the locale you specify.
3. Select **Done**.

To set the date and time

1. On the Home screen, select **Start > Settings > Clock & Alarm > Date and Time**.
2. Set the **Time zone**, **Date**, and **Time**, and then select **Done**.

Choose how to be notified about events or actions

A profile is a group of settings that determine how your phone will alert you to phone events such as incoming calls and notifications.

To change the current profile

Profiles are preset phone sound settings to suit different environments or scenarios. For example, you may want to set the phone to Vibrate or Silent profile when you are in a meeting.

1. On the Home screen, scroll down to  on the Shortcut Bar and then select **Change Profile**.
2. Choose a new profile, and select **Done**.

Tip To quickly change the profile, press and hold the HOME key to display the Quick List and choose a profile.

To edit a profile

1. On the Home screen, scroll down to  on the Shortcut Bar and then select **Change Profile**.
2. Select the profile to edit.
3. Select **Menu > Edit**.
4. Modify the settings, and select **Done**. To cancel without saving changes, select **Cancel**.

Tip To revert to the default profile settings, select **Menu > Reset to default**.

To change the ringtone

1. On the Home screen, scroll down to  on the Shortcut Bar and then select **Change Ringtone**.
2. For the desired event, select a sound. Select **None** if you do not want to hear a sound.
3. Select **Done**.

Notes

- For ringtones, you can use sound files in either the .wav, .mid, .wma, or .mp3 file format. For notifications or reminders, you can use .wav or .mid files.
- Music files in the **My Music** folder cannot be used as ringtones.

Tip When you select a sound, the sound plays. To hear it again, select **Menu > Play**.

To copy a sound to your phone

After a sound file is copied to your phone, you can use it for a ring tone, notification, or reminder. Sound files in either .wav, .mid, .wma, or .mp3 formats can be used.

1. Connect the phone to your PC using a USB connection.
2. On your PC, copy the sound file you want.

3. Do one of the following:
 - In Windows Mobile® Device Center, click **File Management > Browse the contents of your device.**
 - In ActiveSync® on your PC, click **Explore** and double-click **My Windows Mobile-Based Device.**
4. Save the sound file on your phone by going to **Application Data > Sounds**, and pasting the file into that folder.

To set an alarm

1. On the Home screen, select **Start > Settings > Clock & Alarm > Alarm 1 or Alarm 2.**
2. In **Alarm 1 / Alarm 2**, enter the time for the alarm to go off.
3. In **Alarm 1 / Alarm 2**, choose what days you want the alarm to go off.
4. Choose the alarm sound, type, and volume and then select **Done.**

Set personal information

Entering and displaying owner information are best practices; they allow someone to return the phone to you in case it is lost.

To enter owner information

1. On the Home screen, select **Start > Settings > Owner Information.**
2. Enter the necessary information and then select **Done.**

Set performance and maintenance options

To change accessibility settings

1. On the Home screen, select **Start > Settings > Accessibility.**
2. Select your preference for the following:
 - In **System font size**, set the size of the font that is displayed on the screen.
 - In **Multipress time out**, set the length of time between key presses when entering text in Multipress mode.

- In **Confirmation time out**, set the delay before an unconfirmed action times out.
- In **In-call alert volume**, set the volume for incoming call or receiving new message alerts while you are in a call.

3. Select Done.

To change power management settings

Use Power Management to check the battery and configure settings that prolong battery life.

1. On the Home screen, scroll down to  on the Shortcut Bar, then select **Manage Battery**.
2. Adjust the following settings:
 - In **Backlight time out on battery / AC**, select the amount of time for the phone to be idle before the backlight turns off when using the battery or AC power.
 - In **Display time out on battery / AC**, select the time limit for the phone to be idle before the screen turns off when using the battery or AC power.
 - In **Backlight brightness**, set the backlight brightness to **Low**, **Medium**, **High**, or **Very High**.
Tip Select **Low** or **Medium** to increase battery performance.
 - In **USB charge**, select **Off** if you do not want to charge the battery when the device is connected to a computer.
3. Select **Done**.

Tip **Main battery** indicates the amount of battery life remaining.

To find the operating system version number

On the Home screen, select **Start > Settings > About**.

To find the phone specification

On the Home screen, select **Start** > **Settings** > **Device Information**.

4.2 Adding and Removing Programs

Before you purchase additional programs for your phone, make sure that they are compatible with your phone.

To add programs

1. Download the program to your PC (or insert the disc that contains the program into your PC). You may see a single *.exe file, a *.zip file, a Setup.exe file, or several versions of files for different device types and processors. Be sure to select a program designed for your phone and processor type.
2. Read the installation instructions that come with the program.
3. Connect your phone to the PC and then double-click the *.exe file.

To remove a program

1. On the Home screen, select **Start** > **Settings** > **Remove Programs**.
2. Scroll to the program to remove and then select **Menu** > **Remove**.

4.3 Using Task Manager and Managing Memory

To check how much memory is available

1. On the Home screen, select **Start** > **Settings** > **About**.
2. Scroll down to **Available Memory**.

To close running programs in Task Manager

Task Manager lets you close programs currently running on your phone to free up storage space.

1. On the Home screen, scroll down to  on the Shortcut Bar, then select **Improve Performance**.
2. Choose a program on the list and select **End Task**.

On the Task Manager screen, select **Menu** to open a list that lets you go to a specific program, stop running programs, and view system information.

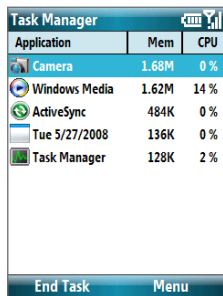

Application	Mem	CPU
Camera	1.68M	0 %
Windows Media	1.62M	14 %
ActiveSync	484K	0 %
Tue 5/27/2008	136K	0 %
Task Manager	128K	2 %

4.4 Managing and Backing Up Files

You can back up files to your PC using Windows Mobile® Device Center or ActiveSync® or copy files to a storage card that is installed on your phone. You can also efficiently manage your files and folders using File Explorer installed on your phone.

Copy files to a PC using Windows Mobile® Device Center or ActiveSync®

1. Connect your phone to your PC.
2. In Windows Mobile Device Center, click **File Management > Browse the contents of your device**.
Or
In ActiveSync on your PC, click **Explore**. This opens the Mobile Device folder for your phone.
3. Browse your phone for files that you want to copy to your PC.
4. Select and copy the files [**Ctrl + C**] and then paste them [**Ctrl+V**] to the destination folder in the PC.

Copying a file results in separate versions of a file on your phone and PC. Changes made to one file will not affect the other since the files are not synchronized.

Use File Explorer

File Explorer provides many easy-to-use features for file and folder management.

To start File Explorer

On the Home screen, select **Start > Applications > File Explorer**.

File Explorer operates in the following two views:

- List View
- Icons View

File Explorer displays the entire file structure in your phone's memory. The functions focus primarily on folder management. When initially started, File Explorer is in List View by default. To switch between views, select **Menu > View > Icons** or **List**.

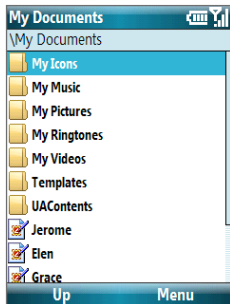

File Explorer - List View

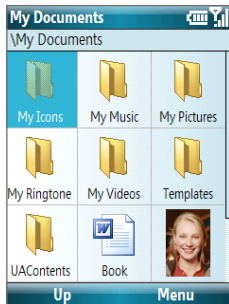

File Explorer - Icons View

In File Explorer, select **Menu** to open a list that lets you send or beam the file, view the file's properties, sort the files, and more.

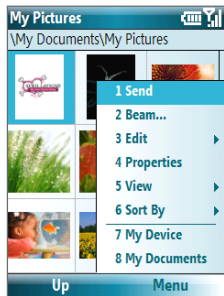

To send a file as an e-mail attachment

1. In File Explorer, select a file and select **Menu > Send**.
2. On the Messaging screen, select an e-mail account. The file will automatically be attached to the new message.
3. Specify the recipient and subject, and type your message.
4. Select **Send**.

Note You can also send the file using Picture Message.

4.5 Protecting Your Phone

You can protect your phone from unauthorized use by requiring a PIN (personal identification number) to make calls. Your default PIN is **1234**. Additionally, you can also lock the entire phone.

To enable the SIM PIN

1. On the Home screen, select **Start > Settings > Security > Enable SIM PIN**.
2. Enter the PIN and then select **Done**.

Note To cancel without enabling the SIM PIN, select **Cancel**.

To disable the SIM PIN

1. On the Home screen, select **Start > Settings > Security > Disable SIM PIN**.
2. Enter the PIN and then select **Done**.

To change the SIM PIN



Be sure to write down your PIN. When the SIM PIN is enabled, you must provide this PIN to unlock the phone.

1. Select **Start > Settings > Security > Change SIM PIN**.
2. In **Old PIN**, enter the current PIN.
3. Enter and confirm the new PIN, and then select **Done**.

To lock the phone

Locking the phone turns off its functionality. This is a helpful feature if, for example, the phone is turned on and in your pocket, and you want to prevent accidental keypresses. Once the phone is locked, the left **SOFT KEY** label changes to **Unlock**.

You can lock the phone by:

- Pressing and holding  for about 2 seconds.
- Pressing and holding  for about 2 seconds (must not be in a text box).

You can also set phone lock options for when the keyboard is closed. Select **Settings > Slide and Key Lock > Close keyboard** to set the following options:

- **Ask, then lock device:** closing the keyboard prompts the user to lock the phone. Select **Yes** to lock the phone, **No** to not lock the phone.
- **Do not lock:** closing the keyboard does not lock the phone.
- **Lock without asking:** closing the keyboard locks the phone without prompting the user.
- **Auto lock after backlight off:** closing the keyboard does not lock the phone. The phone locks automatically after the backlight turns off.

Note You can still receive calls and make emergency calls when the phone is locked.

To automatically enable password protected phone lock

1. On the Home screen, select **Start > Settings > Security > Device lock**.
2. Select **Prompt if device unused for** and then select the amount of time for the phone to be inactive before automatically locking.
3. Select the **Password type**, then enter and confirm your password.
4. Select **Done**.

To unlock the phone

Depending on whether the keyboard is opened or closed, you can unlock the phone by:

- Selecting **Unlock** and pressing the **HOME** key.
- Opening the keyboard if it is closed.

Note If a password has been enabled, you will be prompted for the password when you unlock the phone.

To disable the phone lock

Select **Unlock** and then enter the password you have set to unlock your phone.

To set keyboard lock options

1. Select **Start > Settings > Slide and Key Lock**.
2. Choose to enable or disable **Automatic device lock** and/or **Close keyboard**.
 - Enabling **Automatic device lock** locks the phone when the phone is idle.
 - Enabling **Close keyboard** prompts a message if you want to lock the phone or not when you close the keyboard.

To encrypt files on the microSD card

Select **Start > Settings > Security > Encryption** and choose **Encrypt files placed on storage cards**.

4.6 Restarting Your Phone

Restart your phone when a program is not performing properly or the phone is not responding to any keypresses.

To restart the phone

1. Remove the battery.
2. Wait 3 seconds, then reinsert the battery and turn on your phone.

WARNING! Any unsaved work will be lost if you restart the phone while a program is running.

4.7 Resetting Your Phone

Resetting your phone will remove all the data from its memory and restore the phone back to the factory default settings.

WARNING! All your data will be deleted, it is recommended that you back up your data first before resetting your phone.

To reset your phone

1. Select **Start > Device Management > Clear Storage**.
2. Follow the on-screen instructions to reset the phone.

The phone will restart after it has been reset.

Note If **Encrypt files placed on storage cards** is or was enabled before, then back up all files from the storage card before using Clear Storage, hard reset, or updating the ROM system software. Otherwise you will no longer be able to access the encrypted files on the storage card. Use ActiveSync® or Windows Mobile® Device Center to transfer files between your storage card and computer. After the procedure, copy your files back to the storage card.

Chapter 5

Organizing Phone Information

5.1 Contacts

5.2 SIM Manager

5.3 T-Mobile myFaves®

5.4 Calendar

5.5 Tasks

5.6 Mobile Backup

5.7 Voice Recorder

5.1 Contacts

Contacts is your address book and information storage for the people and businesses you communicate with.

If you use Outlook on your PC, you can synchronize contacts between your phone and PC.

To open contacts

On the Home screen, select **Contacts** or **Start > Contacts**.

Create a contact on your phone

To create a new contact on your phone

1. On the Home screen select **Start > Contacts > New > Outlook Contact**.

Note If you do not have a SIM card inserted, selecting **Start > Contacts > New** takes you directly to creating an Outlook Contact.

To create a new contact on your SIM card, select **Start > Contacts > New > SIM Contact**. You can also use SIM Manager to add contacts to your SIM card. For more information about SIM Manager, see “SIM Manager” in this chapter.

2. Enter information for the new contact.
 - To easily identify who is calling you, you can assign a custom ring tone to each Outlook contact. To assign a custom ring tone, scroll down to and select **Custom ring tone**, and then select the ring tone.
 - To assign a picture to a contact, scroll down to **Picture**, select **Select a picture**, and then choose the desired picture. To remove the picture, select **Menu > Remove Picture**.
3. Select **Done**.

Tip If someone who is not in your list of contacts calls you or sends you a message, you can quickly create a contact from Call History or from the message by selecting **Menu > Save to Contacts**.

Edit and call a contact

To view and edit a contact information

1. On the Home screen, select **Start > Contacts**.
2. Select the contact whose information you want to view or edit and select **Menu > Edit**.
3. When finished making changes, select **Done**.

To call a contact from the contact list

1. On the Home screen, select **Start > Contacts**.
2. Select the contact to call and then press . The contact's default phone number is dialed.

Tip To call a phone number other than the default, select the contact, scroll to the number you want to dial, and then press .

Find a contact

To find a contact

1. On the Home screen, select **Start > Contacts**.

Note If you are not in Name view, select **Menu > View By > Name**.

2. Do one of the following:
 - Begin entering a name or phone number of the contact until the contact is displayed. When you press a key, such as **5**, you find names that begin with **G** and **H**, as well as phone numbers that start with **5**. The next key you press continues to narrow the search.
 - If you have assigned categories (e.g. Business) to your Outlook contacts, you can filter the contact list by categories. In the contact list, select **Menu > Filter** and then select a category. To show all contacts again, select **All Contacts**.
 - If you have entered information under **Company** for your Outlook contacts, you can quickly locate the contacts that work for a specific company on your phone. In the contact list, select **Menu > View By > Company**. Select the company to see the contacts who work there.

Share contact information

To beam contact information to another device via Bluetooth

1. On the Home screen, select **Start > Contacts** and then select the contact whose information you want to beam.
2. Select **Menu > Send Contact > Beam**.
3. Select the device where you want to beam the contact details to and select **Beam**.

Note Before you can beam, make sure Bluetooth is turned on and set to **Visible** mode on your phone and the target mobile device. For more information, see “Bluetooth” in Chapter 8.

To send contact information via a text message

1. On the Home screen, select **Start > Contacts** and then select the contact whose information you want to send.
2. Select **Menu > Send Contact > Text/Multimedia**.
3. Select the contact information that you want to send and select **Done**.
4. In the new text message, enter the mobile phone number of the person to whom you are sending the contact information to and then select **Send**.

To send contact information via Picture Message

1. On the Home screen, select **Start > Contacts**.
2. Select a contact and then select **Menu > Send as vCard**.
3. Enter the recipient in **To** of the Picture Message and then select **Send**.

5.2 SIM Manager

SIM Manager lets you view the contents of your SIM card and transfer contacts from your SIM card to your phone and vice versa.

To create a contact on your SIM card

1. Select **Start > Device Management > SIM Manager**.
2. Select **New** and enter the contact name and phone number.
3. Select **Save**.

Tip To change contact information on your SIM card, select a contact and select **Menu > Edit**. After modifying, select **Save**.

To copy SIM contacts to your phone

1. Select **Start > Device Management > SIM Manager**.
2. Select a SIM contact or select all SIM contacts by selecting **Menu > Select All**.
3. Select **Menu > Save to Contacts**.

To copy phone contacts to the SIM card

You can only store one phone number on a SIM card for each contact. When you copy a contact that has several phone numbers to your SIM card, SIM Manager saves each number under a separate name.

To save each number under a different contact name on the SIM card, SIM Manager appends an indicator at the end of each name. You can edit this indicator first before you start copying contacts to your SIM card.

1. Select **Start > Device Management > SIM Manager > Menu > Tools > Options**.
2. On the Options screen, select the check boxes of the types of phone numbers that you want to be added to the SIM card.

- Under the **Mark** column, you can change the indicator that will be appended to the SIM contact names for each phone number type. To do so, select a phone type, select **Edit**, enter your desired indicator and then select **Save**.
- After modifying, select **OK**.
- Select **Menu > Contacts to SIM**.
- Select the check boxes of the contact's phone numbers that you want to copy to your SIM card and then select **Save**.

To display your phone number in SIM Manager

- On the SIM Manager screen, select **Menu > Tools > List of Own Numbers**.
- Select **Edit**.
- Change the name, if desired, then enter your mobile phone number.
- Select **Save**.

When your phone number is stored on the SIM card, it will appear on the SIM Manager screen.

SIM Manager		
My No. 0988		
#	Name	Phone
7	Ada	095555555
9	Al Geddy	099954545
4	Alex	1111111
3	Ken	093355555
6	Lillian	093355555
13	Mary	020755522
15	Melody	020777533
12	Mom mobile	095554444
14	Norm	020777777
New		Menu

5.3 T-Mobile myFaves®

T-Mobile myFaves helps you stay connected to the people who matter most in your life. Simply choose any five U.S. phone numbers you call most often, on any network, and have them displayed on your phone's main screen.

For more information about the benefits of using T-Mobile myFaves and how to subscribe to this service, visit <http://www.t-mobile.com>.

T-Mobile myFaves on the Home screen

Once you activate your subscription to T-Mobile myFaves service, myFaves will show on your phone's Home screen. You can add and call contacts by simply selecting the circles you see on the Home screen when you have the myFaves icon () selected. You can also associate your contacts with preset icons or their actual photos.

Note A notification icon appears on the bottom-right side of the myFaves contact if there is a new message and/or missed call from that myFaves contact.



Notification icons

Turn the **NAVIGATION WHEEL** to go through your myFaves contacts and then press **CENTER SELECT** to add, call, edit or view a contact.

Add myFaves contacts

To add myFaves contacts, you can create new contacts or add existing contacts from your phone or SIM card.

1. Select an empty circle on the Home screen.
2. Choose whether to create a new contact or use an existing contact.

Note If you choose **Create New**, you need to fill in the **Name** and **Number**.

3. Under **Icon**, select **Change icon** to associate the contact with an image. You can choose to take a picture, download from the T-Mobile site, or use an existing image or icon on your phone.

Tip You can crop and rotate photos before you using them as myFaves icons. See "Rotate and crop a picture" for details.

4. Set a **Ring tone** for the contact.
5. Select the **Birthday** and/or **Anniversary** reminder check boxes according to your preference and enter the date.
6. Set a **Reminder** for each event. On the day of the reminder, a screen will open letting you quickly call, send a text message, or buy a gift for the contact.

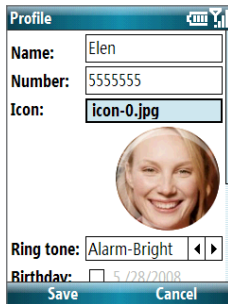
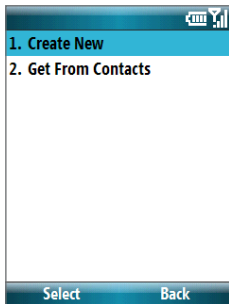

7. Select **Save**. In the Confirmation screen, select **Yes**.
8. Select **OK** in the two succeeding screens.

Rotate and crop a photo

1. Create a new myFaves contact or edit the profile of an existing myFaves contact. See “Add myFaves contacts” and “Edit a myFaves contact” for details.
2. On the Profile screen, select **Icon > Take Picture or My Pictures**.
3. Take a picture or open an existing photo from your phone.
4. Select **Options > Rotate** to rotate the photo 90 degrees clockwise. Every time you select **Rotate**, the image rotates 90 degrees clockwise.



5. Select **Options > Zoom In or Zoom Out** to select the best view of the subject.
6. Use the **NAVIGATION WHEEL** to position the crop guide to where you want to crop the photo.
7. Select **Crop**. The photo is now set as the myFaves contact’s icon.

Call a myFaves contact

1. On the Home screen, select the myFaves contact you want to call.
2. On the Profile screen, select **Call**.

Tip You can also select the myFaves contact and press  to call the contact.

You can also choose to send the contact an e-mail, text message, instant message, multimedia message, or audio postcard. To learn about the different messaging options, please see Chapter 6.

To view the activity log of the contact

On the Profile screen, select **Activity Log** to view the information for the selected contact. From the Log screen, you can read a new text message, view/reply a missed call, play a voice note, and more.

To open the item, press **CENTER SELECT**.

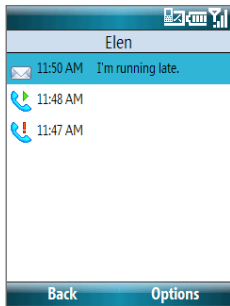

myFaves settings

You can change your myFaves preferences. To change your myFaves settings, select **Start > myFaves Settings**.

- Select **Display** to set whether you want your myFaves contacts to be **Always On**, meaning displayed on the Home screen or **Minimized**. When you select **Minimized**, you need to press the **CENTER SELECT** key to show your myFaves contacts.
- Select **Menu style** to change how the myFaves contact options are displayed. You can choose either **List** or **Circle**.

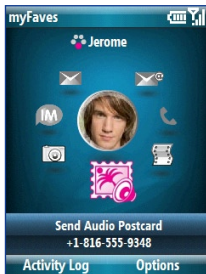

Menu Style: Circle



Menu Style: List

- Select **myFaves Icons** to let you set an icon for a current or new myFaves contact. You can choose to take a picture, use icons or pictures in your phone, or download icons from the T-Mobile Web site.
- Select **Refresh myFaves** to synchronize with the myFaves server. Use this feature when your myFaves details don't refresh immediately after you edit them.
- Select **About myFaves** to go online and view details about the myFaves service.
- Select **Restore myFaves home screen** to restore the home screen if you have changed the home screen in Settings. This setting is unavailable if the T-Mobile home screen is active.

Edit a myFaves contact

1. On the Home screen, select the myFaves contact you want to edit and then select **Options**.
2. In the Options menu, select one of the following:
 - **Edit Profile.** Modify the contact's name, phone number, or photo.
 - **Edit Email.** Add or change the e-mail address of the selected contact.
 - **Replace Contact.** Replace with another contact.
 - **Change Order.** Set a contact as your primary myFaves contact. It will appear as your first myFaves contact on the Home screen, and will also be selected automatically whenever you launch the myFaves program.
 - **myFaves Settings.** Set myFaves options such as the display mode and menu style. You can also download myFaves icons and refresh the myFaves page.

Tip You can also access the **myFaves Settings** option by selecting **Start > myFaves Settings** on the Home screen.

5.4 Calendar

Use Calendar to schedule appointments, including meetings and other events. If you use Microsoft® Office Outlook® on your PC, you can synchronize appointments between your phone and PC.

Create a personal appointment

To set Calendar options

1. On the Home screen, select **Start > Calendar**.

Tip Calendar can also be accessed by selecting **Today** while viewing appointments on the Home screen

2. Select **Menu > Tools > Options**.
3. Scroll through the available settings and set your desired default options.
4. Select **Done**.

To schedule an appointment

1. On the Home screen, scroll down to  on the Shortcut Bar, then select **New Appointment**.
2. Enter information about the appointment.
 - To schedule an all-day event, go to **End time** and then select **All day event**.
 - To make the appointment recurring, select **Occurs**.
3. Select **Done**.

Note All-day events do not occupy blocks of time in the Calendar; instead, they appear in banners at the top of the calendar.

View your appointments

To view your schedule

You can view your schedule in three different views: Month, Week, and Agenda.

1. On the Home screen, scroll down to  on the Shortcut Bar, and then select **New Appointment > Today**.
2. Press the left **SOFT KEY** or select **Menu** and choose the view you want.

Highlighted areas represent time segments that have scheduled appointments.

Select to change the view.

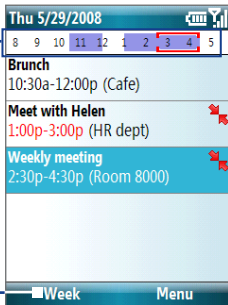

Select an item to view the details of the appointment.

An appointment with the  icon indicates that the scheduled appointment has a conflict with one or more existing appointments.

Agenda View

Send appointments

To send a meeting request

You can send meeting requests via e-mail to people that use Microsoft® Office Outlook® or Microsoft® Office Outlook® Mobile.

1. On the Home screen, scroll down to  on the Shortcut Bar, and then select **New Appointment**.
2. Schedule a new appointment and then scroll down to **Attendees** and select **No Attendees**.
Select **Add Required Attendee** or **Add Optional Attendee** to add the contacts to who you want to send the meeting request.

Note You can only specify if an attendee is required or optional if your phone is connected to a Microsoft Exchange® 2007 server. Otherwise, all attendees are designated as required. For more information, see Chapter 7.

3. Choose the contact(s) you want to send the meeting request to and select **Select**.

Note To remove an attendee from the list, select the attendee and select **Menu > Remove Attendee**.

4. On the New Appointment screen, select **Done**. The meeting request is sent.

Note When attendees accept your meeting request, the meeting is automatically added to their schedules. When their response is sent back to you, your calendar is updated as well.

To send a calendar appointment

You can send a calendar appointment to another phone over Picture Message.

1. On the Home screen, scroll down to  on the Shortcut Bar, and then select the appointment you want to send.
2. Select an appointment and then select **Menu > Send as vCalendar**.
3. Enter the recipient in the **To** line of the Picture Message and then select **Send**.

5.5 Tasks

Use Tasks to keep track of things you need to do.

To create a task

1. On the Home screen, select **Start > Applications > Tasks**.
2. Select **Menu > New Task**.

Tip To quickly add a task, type the task in **Enter new task here** and press the Enter key.

3. Enter the necessary task information and select **Done**.
 - Set a **Priority** for the task. This item can be referenced when sorting tasks.
 - Enter a **Start date** and **Due date** if the task starts and ends at a specific time.
 - Enter a **Reminder** if you want to be notified if the task is due.
 - Enter the **Categories** (you can set more than one) that best describes the task. This item can be referenced when filtering tasks.

Notes

- You can synchronize information on your phone with your PC to keep your task list up to date in both locations.
- If you create a new task with a reminder on your PC and then synchronize tasks with your phone, the reminder will play at the time that was set on your PC.

To locate a task

1. On the Home screen, select **Start > Applications > Tasks**.
2. In the task list, do one of the following:
 - To sort the list, select **Menu > Sort by** and then select a sort option.
 - To filter the list by category, select **Menu > Filter** and then choose the category you want displayed.

To mark a task as completed

1. On the Home screen, select **Start > Applications > Tasks**.
2. Select the task and then select **Complete**.

Tip To mark the task as incomplete select **Activate**.

5.6 Mobile Backup

Mobile Backup is a tool that lets you back up and synchronize your contacts on your phone with the T-Mobile Web site. You need an active connection (e.g. EDGE) to use the Mobile Backup.

To set up Mobile Backup

1. Select **Start > Device Management > Mobile Backup**.
2. Select **Yes** to begin the setup process. You will then be asked to copy SIM contacts to your phone first, since Mobile Backup only lets contacts that are stored on your phone be synchronized with the T-Mobile Web site.

Note If your phone has existing contact entries, you will be asked if you want to replace them with the SIM card contact entries or merge the SIM card contact entries with the phone contact entries.

3. Select **Yes** to copy.

To synchronize with the T-Mobile Web site

On the Mobile Backup screen, select **Sync now**.

To view synchronization history

On the Mobile Backup screen, select **Sync History**.

5.7 Voice Recorder

Use Voice Recorder to create short voice recordings. Voice recordings are included in the All Notes list and are named consecutively (Recording1, Recording2, and so on).

To create a voice recording

1. On the Home screen, select **Start** > **Applications** > **Voice Recorder**.
2. Hold the phone's microphone near your mouth.
3. Select **Record** and say your message.
4. Select **Stop** to stop recording.

To delete a voice recording

1. On the Home screen, select **Start** > **Applications** > **Voice Recorder**.
2. Select the voice recording to delete and select **Menu** > **Delete**.
3. Select **Yes**.

Tip If you delete a voice recording that has a default name, such as Recording1, this name becomes available for a new voice recording.

To listen to a voice recording

1. On the Home screen, select **Start** > **Applications** > **Voice Recorder**.
2. Select the voice recording to play and then press **CENTER SELECT**.

Tip To stop listening to the voice recording, select **Stop** while the voice recording is playing.

To use a voice recording as a ring tone

1. On the Home screen, select **Start** > **Applications** > **Voice Recorder**.
2. Select the voice recording and then select **Menu** > **Set As Ringtone**.

Chapter 6

Exchanging Messages

6.1 Messaging

6.2 Text Messages

6.3 Picture Messages

6.4 Audio Postcards

6.5 Use Instant Messaging

6.6 Set Up E-Mail

6.7 Use E-mail

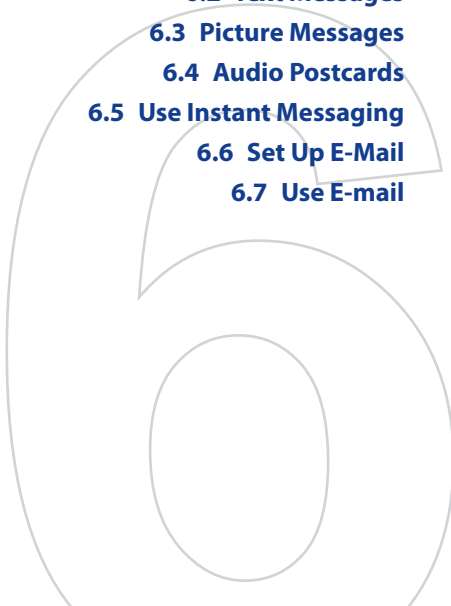

6.1 Messaging

Messaging is where all your e-mail, text message, and Picture Message accounts are located. When you receive a new message, you can open that particular message from the Home screen. Simply scroll down to the **Notifications** icon on the Shortcut Bar then select the message.

On the Home screen, scroll down to  on the Shortcut Bar and then select the account you want to open.

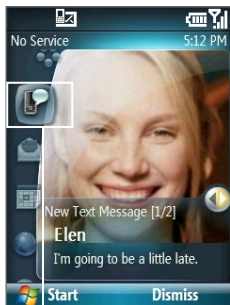

Notifications icon on the Shortcut Bar.

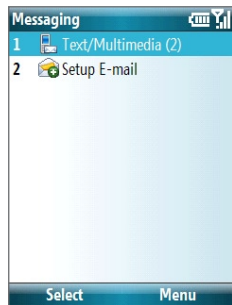

Messaging screen

While in a messaging account's main screen, select **Menu > Tools > Switch Accounts** to switch to another message account.

To change message account settings

- On the Messaging screen, select the message account whose settings you want to change and select **Menu > Settings**.
- On a message account's message list, select **Menu > Tools > Options**.

6.2 Text Messages

Send short text messages to your contacts.

Compose and send text messages

To compose and send a text message

1. On the Home screen, scroll down to  on the Shortcut Bar, scroll to **Text Messages**, and select **Compose** using the right soft key.
2. Enter the mobile phone number of one or more recipients, separating them with a semicolon (;). To access phone numbers from Contacts, in **To**, press **CENTER SELECT** and then select a recipient from the list.

Tip Press  and then press 1 to enter a semicolon.

3. Enter your message. You can enter up to 160 characters in one message.
4. Select **Send**.

Tips

- To cancel the text message, select **Menu > Cancel Message**.
- If you want to know if your text message was received, before sending the message, select **Menu > Message Options** and select **Request message delivery notification**.

Manage text messages

Text messages that are sent to and received from a contact (or number) are grouped as a single thread in your inbox. Threaded SMS lets you see exchanged messages (similar to a chat program) with a contact on the screen.

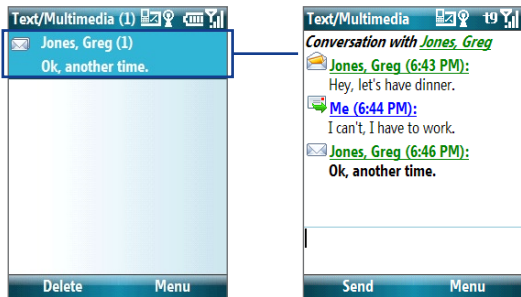

Notes

- A single thread per contact (or number) is maintained in the Text Messages inbox.
- You can turn off threaded text messaging. From the Home screen, select **Start > Settings > Text Messaging Layout**, and change **Threaded** to **Unthreaded**.

To respond to a message

1. In the **Text Messages** inbox, select the message to open it.
2. At the bottom of the screen, type your message and then select **Send**.

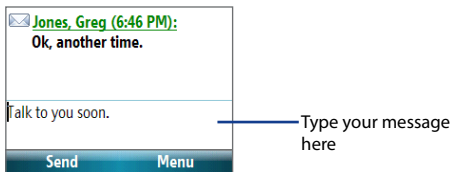

To delete a message in the thread

1. In the **Text Messages** inbox, select the message to open it.
2. Select the message in the thread you want to delete.
3. Select **Menu > Delete**.

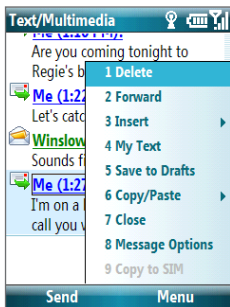

Note If you do not select a message in the thread, the **Delete** option is unavailable.

Tip To delete the entire thread, select the message thread in the Text/Multimedia inbox and select **Delete**. You will be prompted to delete all of the messages in the conversation or conversations. Select **Yes** to confirm the deletion or **No** to cancel.

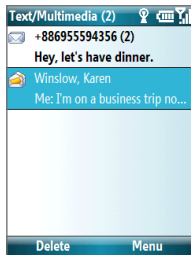

Receive text messages

Text messages are automatically received when the phone function is turned on. When the phone is turned off, text messages are held by T-Mobile until the next time the phone is turned on.

- Save your text messages (SMS) messages to your SIM card by highlighting a message in a message thread and selecting **Menu > Copy to SIM**.
- Copy text messages (SMS) saved on your SIM card to the Inbox by selecting **Menu > Copy to Phone**. Copying them to your phone results in duplicate messages in the Inbox folder when the SIM card is in use.
- The icon  next to a message indicates that it is saved on the SIM card.

Copy and paste text

Copy words or lines of text in your messages and then paste them on a message.

To copy text from a text message or e-mail

1. Open the message where you want to copy text from.
2. Select **Menu > Copy/Paste > Select Text**.
3. Use the **NAVIGATION CONTROL** to position the cursor where you want to start copying and then select **Select**.

Tip Select **Menu > Copy/Paste > Select All** to select the whole message.

4. Press NAVIGATION right or left until you have selected the text you want to copy and then select **Copy**.

Tip Press **NAVIGATION** up or down to select the whole line of text.

To paste text on a text message or e-mail

In a text message or e-mail, select **Menu > Copy/Paste > Paste**.

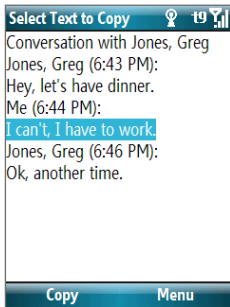

6.3 Picture Messages

Sending Picture Messages (MMS) to your friends and family is fun and easy. You can include pictures, video, and an audio clip in a picture message.

To access Picture Messages

On the Home screen, scroll down to  on the Shortcut Bar and then scroll to **Picture Messages**.

Note When you purchase your phone, it is already preset with T-Mobile's Picture Message settings. If you accidentally lost the preset settings or you want to add another wireless service provider, you can configure the settings while composing a Picture Message.

Create and send Picture Messages

You can compose Picture Messages in a combination of various slides, where each slide can consist of a photo, audio or video clip, and/or text.

To start composing a Picture Message

1. On the Home screen, scroll down to  on the Shortcut Bar and then scroll to **Picture Messages** and select **Compose** using the right soft key.
2. In **To**, enter the recipient's phone number or e-mail address.
3. In **Subject**, enter a subject for your message.
4. Select **Insert Picture/Video** to select a photo or video clip from the Select Media screen and insert it. To capture a new photo or video, select **Menu > Capture Picture/Video**.

Tip After inserting a Picture message element, press **NAVIGATION WHEEL** right to add a new slide.

5. Select **Insert Text** to enter text for your Picture Message.
 - To insert predefined text or emoticons, select **Menu > Insert My Text** or **Insert Emoticon**.
 - To insert contact details of a contact or appointment details, select **Menu > Insert Contact** or **Insert Calendar**. You can then choose the details that you want to insert.
6. Select **Insert Audio** to insert an audio clip. Select an audio clip on the Select Audio screen. To record a new audio clip, select **Menu > Capture Audio**
7. Select **Send** to send the message.

Notes

- To send a copy of this message to others, access **Cc** and **Bcc** by scrolling up from the **To** field.
- To remove the photo, text, or audio, select the item and press the **BACK** key.

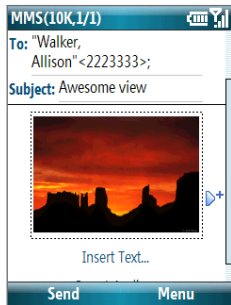

View, reply to and block Picture Messages

To receive a Picture Message

On any Message folder screen, select **Menu** > **Send/Receive**. By default, messages are automatically downloaded to your phone.

To view a Picture Message

You can view Picture Messages in several ways.

- Select the message and press **CENTER SELECT** to view the message on your phone. Select **Pause** or **Menu** > **Stop** to pause or stop the message playback.
- Select **Menu** > **Contents View** to see a list of files included in the message. To open a file, select it and then select **Open**. To save a file, select it, and then select **Menu** > **Save Audio**, **Save Photo**, **Save Video**, or **Save File**.
- View each slide included in the message by selecting **Menu** > **Next**.

To reply to a Picture Message

1. In the **Picture Messages** inbox, select the message to open it.
2. At the bottom of the screen, type your message.
3. Select **Send**.

Tip Select **Menu** > **Forward to** forward the message to someone else.

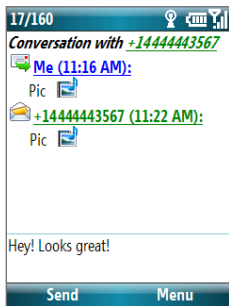

To block a phone number from sending you Picture Messages

You can choose to block a phone number from sending you Picture Messages if you do not want to receive future Picture Messages from that number.

1. View the Picture Message and then select **Menu > Show > Contact Details**.
2. In the Contact Details screen, select the contact in the **From** field.
3. Select **Menu > Save to Blacklist**.

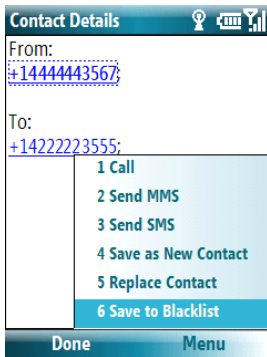

Note By adding the number to the Blacklist, you will not receive future Picture Messages from that number. To edit the MMS Blacklist, from the Home screen, select **Start > Settings > Multimedia Messaging > Menu > Edit Blacklist**. Here, you can remove a number from the Blacklist or change the name of the blacklisted contact.

6.4 Audio Postcards

Quickly add a voice recording to captured photos and then send them to family and friends as audio postcards.

Note You need a T-Mobile data plan to send audio postcards.

To create and send an audio postcard

1. On the Home screen, scroll down to  on the Shortcut Bar and then scroll to **Audio Postcards** and select **Compose** with the right soft key.
2. In the Camera screen, press **NAVIGATION WHEEL** left/right to select the template you want to use.
3. Aim the camera at the subject and then press **CENTER SELECT** to take the shot.

Note Depending on the template selected, you may need to take more than one shot.

4. In the Review screen, select . The Audio Postcard screen opens.

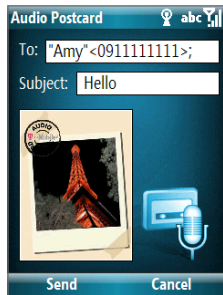
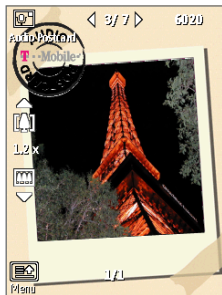

5. Hold the phone's microphone near your mouth and select **Record**.
6. After recording your voice message, select **Stop**.

Note Select **Menu > Play** to play back the recorded voice clip. If you are not satisfied with the recording, select **Menu > Record Again**.

7. Select **Send**. In **To**, enter the recipient's mobile phone number or e-mail address.

Note If you opened Audio Postcards from myFaves, selecting **Send** will automatically send the audio postcard to the selected myFaves contact.

Tips

- In the **To** field, press **CENTER SELECT** to choose a contact from your Contacts list.
- You can send the audio postcard to multiple recipients. Separate recipients with a semicolon.

8. Enter the **Subject** and then select **Send**.

6.5 Use Instant Messaging

AIM®

You will need an AIM® account to use instant messaging. To set up an account, go to <http://www.aim.com/t-mobile>.

To sign on

1. On the Home screen, select **Start > Instant Messaging**.
2. Select **AIM**.
3. Type your screen name and password. Note that your password is case-sensitive.
4. Scroll to **Save password** and **Auto-Sign On**, and then press **CENTER SELECT** to place checks in the check boxes, if desired.
5. Select **Sign On**.

To sign off

1. At Buddy List®, select **Menu > Sign Off**.
2. Select **Yes**.

To add a buddy

1. At Buddy List®, select **Menu > Add Buddy**.
2. Type your buddy's screen name and then select **Add**.

To delete buddy

1. At Buddy List®, scroll to the buddy you want to delete.
2. Select **Menu > Delete Buddy**.
3. Select **Yes**.

To send messages to a buddy

1. At Buddy List®, scroll to and select the buddy you want to send a message.
2. Select **Menu > Send IM**.
3. Type your message and then select **Menu > Send IM**.

To send message to unlisted buddy

1. At Buddy List®, select **Menu > Send IM to**.
2. Type your buddy's screen name and then select **OK**.
3. Type your message and then select **Menu > Send IM**.

To block buddy

1. At Buddy List®, scroll to the buddy you want to block.
2. Select **Menu > Block**.
3. Select **Yes**.

To set away status

1. At Buddy List®, select **Menu > My Status**.
2. Scroll to and select **Away**.

ICQ®

You will need an ICQ account to use instant messaging. To set up an account, go to <http://www.icq.com>.

To sign on

1. On the Home screen, select **Start > Instant Messaging**.
2. Select **ICQ**.
3. Type your ICQ® number and password. Note that your password is case-sensitive.
4. Scroll to **Save password** and **Auto-Sign On**, and then press **CENTER SELECT** to place checks in the check boxes, if desired.
5. Select **Connect**.

To sign off

1. At contact list, select **Menu > Disconnect**.
2. Select **Yes**.

To add contact

1. At contact list, select **Menu > Add User**.
2. Type the contact's ICQ® number and nickname.
3. Select **Add**.

To delete contact

1. At contact list, scroll to the contact.
2. Select **Menu > Delete User**.
3. Select **Yes**.

To send message to a contact

1. At contact list, scroll to the contact.
2. Select **Menu > Send message**.
3. Type your message and then select **Menu > Send message**.

To send message to unlisted contact

1. At contact list, select **Menu > Send message to**.
2. Type the contact's ICQ® number and then select **OK**.
3. Type your message and then select **Menu > Send message**.

To block contact

1. At contact list, scroll to the contact you want to block.
2. Select **Menu > Block**.
3. Select **Yes**.

To set away status

1. At contact List, select **Menu > My Status**.
2. Scroll to and select **Away**.

Yahoo!®

You will need a Yahoo!® account to use instant messaging. To set up an account, go to <http://messenger.yahoo.com>.

To sign in

1. On the Home screen, select **Start > Instant Messaging**.
2. Scroll to and select **Yahoo**.
3. Type your Yahoo! ID and password. Note that your password is case-sensitive.
4. Scroll to **Save password** and **Auto-Sign On**, and then press **CENTER SELECT** to place checks in the check boxes, if desired.
5. Select **Sign In**.

To sign out

1. At contact list, select **Menu > Sign Out**.
2. Select **Yes**.

To add contact

1. At contact list, select **Menu > Add Contact**.
2. Type the contact's Yahoo!® ID and then select **Add**.

To delete contact

1. At contact list, scroll to the contact you want to delete.
2. Select **Menu > Delete Contact**.
3. Select **Yes**.

To send message to contact

1. At contact list, scroll to the contact you want to send a message.
2. Select **Menu > Send a Message**.
3. Type your message and then select **Menu > Send Message**.

To send message to unlisted contact

1. At contact list, select **Menu > Send a Message to**.
2. Type the contact's Yahoo!® ID and then select **OK**.
3. Type your message and then select **Menu > Send Message**.

To set away status

1. At contact List, select **Menu > My Status**.
2. Scroll to and select **Away**.

Windows Live™ Messenger

Refer to “Windows Live™ Messenger” in Chapter 8 to learn how to use Windows Live™ Messenger.

6.6 Set Up E-Mail

Set Up E-Mail provides you unlimited access to your work and personal e-mail. Instantly access your e-mail from AOL® AIM®, Yahoo!®, Gmail™, Microsoft® Exchange and many more, including any POP3 or IMAP4 e-mail server.

Note Restrictions may apply. Contact your e-mail provider for additional information.

To add e-mail accounts using Set Up E-mail

1. On the Home screen, scroll down to  on the Shortcut Bar and then scroll to **Set Up E-mail**.
2. On the Select Account screen, select the type of e-mail accounts you want to add to your device.

Tip Select  if you need more help in setting up an e-mail account.



To set up AOL/AIM® Mail, Yahoo!® Mail, or Gmail™

Select **AOL/AIM Mail**, **Yahoo! Mail**, or **Gmail** and then simply enter your e-mail address and password.

To set up Windows Live Mail

Select **Windows Live Hotmail**, then sign in using your Windows Live ID. See Chapter 8 for details.

To set up Outlook E-mail

1. On the Select Account screen, select **Outlook Setup**.
2. To send and receive personal e-mail on your phone:
 - Check if the synchronization software has been installed on your PC and a sync partnership has been created with your phone. If these have been done, then just connect your phone to your PC to send and receive Outlook e-mails.

If you have not yet installed the synchronization software nor created a partnership, please do so by following the procedures in Chapter 3.
3. To set up your company e-mail account on your phone:
 - Set up your phone to synchronize via a wireless LAN or over-the-air connection with your company's Exchange Server. For more information about synchronizing with the Exchange Server, see Chapter 7.

To set up a POP3 or IMAP4 e-mail account

If you have an e-mail account from an ISP or other Web-based accounts such as Comcast®, add them as POP3 or IMAP4 accounts on your device.

1. On the Select Account screen, select **Other**.
2. Enter your e-mail address and password, then select **Next**.

Notes If your e-mail provider settings cannot be found, you will be prompted to enter settings such as the incoming and outgoing server names. Ask your e-mail service provider about these settings.

To access your e-mail accounts

Select **Start > Messaging**. You will see your e-mail accounts in the Messaging screen.

6.7 Use E-mail

After setting up e-mail accounts on your phone, you can start sending and receiving e-mail messages.

Create and reply to e-mails

To compose and send an e-mail

1. Select **Start > Messaging** and then select an e-mail account.
2. Select **Menu > New**.
3. Enter the e-mail address of one or more recipients, separating them with a semicolon. To access e-mail addresses stored in Contacts, select **To**.
4. Enter a subject and compose your message. To quickly add common messages, select **Menu > My Text** and select a desired message.
5. Select **Send**.

Tips

- To set the priority, select **Menu > Message Options**.
- If you are working offline, e-mail messages are moved to the Outbox folder and will be sent the next time you connect.

To add an attachment to an e-mail

1. In the message that you are composing, select **Menu > Insert** and select the item you want to attach: **Picture**, **Voice Note**, or **File**.
2. Select the file you want to attach or record a voice note.

Filter the Inbox message list

Filter the e-mail messages in your Inbox to only display the e-mails that contain the sender or e-mail subject you are searching for.

Enter the sender name or e-mail subject you want to look for using the keyboard. As you press keys, the list narrows down to the conditions you set.

For example, pressing “J” then “A” narrows the list to only the e-mails that contain sender names, e-mail subjects, and/or message text that starts with “JA.”

Note This feature works for all Messaging accounts.

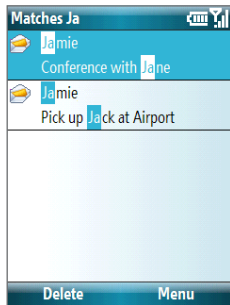

View and reply to e-mails

To read incoming messages

By default, only the first few kilobytes of a message displays when you open and read an incoming message. To read the whole message, do one of the following:

- Scroll down to the end of the message and select **Get the rest of this message**; or
- Select **Menu > Download Message**.

To download an attachment

In an open message with an attachment to download, select the attachment. If there is more than one attachment, select the other attachments to download them. You can directly open the file in the associated program after you download them by selecting the attachment again.

To reply to or forward an e-mail

1. Open the message and select **Menu > Reply > Reply, Reply All, or Forward**.
2. Enter your response. To quickly add common messages, select **Menu > My Text** and then select a desired message.
3. Select **Send**.

Tips

- To see more header information, scroll up.
- To always include the original message from the list view, from the Outlook E-mail screen select **Menu > Tools > Options > Sending** and then select the **Include copy of original message when replying to e-mail** check box.
- In the Outlook E-mail account, you will send less data if you do not edit the original message. This may reduce data transfer costs based on your rate plan.

To view and reply to HTML e-mails

You can receive, view, and reply to HTML e-mails from any type of e-mail account. The HTML format is retained without layout shifting or resizing.

Note HTML e-mail support in Outlook Mobile is available only if your company is using Microsoft Exchange Server 2007.

1. Set the message format to HTML. To find out how to set the message format, see “Customize e-mail settings” in this chapter.
2. Select **Start > Messaging**, select your e-mail account, and then open an HTML e-mail that you received.
3. Scroll down to the end of the message and select **Get the rest of this message** to download the whole message.
4. Scroll up (if needed) and select **Click to scroll right** to be able to scroll sideways to get a complete horizontal view of the message.

Note If images do not immediately appear, select **Internet pictures blocked > Download Internet pictures**.

5. Select **Reply** or select **Menu > Reply** and then choose whether to reply to the sender(s) or forward the message.

6. Enter your response and then select **Send**.

Tip E-mail can contain hyperlinks to Web pages.

Send and download e-mails

The manner in which you send and receive e-mails depends on the type of e-mail account you have.

To send and receive e-mail for an Outlook account

1. Select **Start > Applications > ActiveSync**.
2. Connect your phone to your PC.

Otherwise, connect wirelessly if you are synchronizing Outlook e-mail with your company e-mail server. See Chapter 7 for details.

3. Synchronization automatically begins, and your phone sends and receives Outlook e-mail.

Tip You can also manually synchronize anytime by selecting **Sync** in ActiveSync® or **Menu > Send/Receive** in Outlook Mobile®.

To send and receive e-mail for a POP3/IMAP4 account

If you have an e-mail account with an ISP or a work account that you access using a VPN server connection, you send and receive messages through a remote e-mail server. Before sending and downloading messages, you first need to connect to the Internet or your corporate network.

1. Select **Start > Messaging** and then select your POP3/IMAP4 e-mail account.
2. Select **Menu > Send/Receive**. The messages on your phone and e-mail server are synchronized: new messages are downloaded to the phone Inbox folder, messages in the phone Outbox folder are sent, and messages that have been deleted from the server are removed from the phone Inbox folder.

Customize e-mail settings

To change the download size and format for Outlook e-mail

1. Disconnect your phone from the computer.
2. Select **Start > Applications > ActiveSync**.
3. Select **Menu > Options**, select **E-mail** and then select **Settings**.
4. On the E-mail Sync screen, set the **Download size limit** and **Message format**.
5. Close ActiveSync and then reconnect your phone to the computer.

To change the download size, e-mail format, and other settings for POP3/IMAP4 e-mail

1. Select **Start > Messaging**.
2. Use the up/down **NAVIGATION WHEEL** to select your POP3 or IMAP4 e-mail account, then select **Menu > Settings**.
3. You can make changes to your e-mail address, user name, password, etc., and customize the following settings:

Options	Description
Automatic Send/Receive	Select a time interval for connecting to the Internet automatically to send and receive messages.
Download messages	Set the number of days of messages that you want to be downloaded to your phone.
Send/receive when I click Send	By default, messages are immediately delivered when you select Send . If you prefer to save outgoing messages to the Outbox folder first, clear the check box. (In this case, you will need to manually send messages by selecting Menu > Send/Receive .)

Options	Description
Use automatic send/receive schedule when roaming	Lets your phone data roam when there is a set time interval for connecting to the Internet automatically. Since this may result in higher connection costs, you may want to leave the check box cleared.
When deleting messages	Choose whether to delete messages from the mail server when you delete them on your phone.
Message format	Select HTML or Plain Text.
Message download limit	Select the e-mail download size. If you have large volumes of e-mail, use a lower size or select to download headers only.

4. When you have finished customizing settings, select **Finish**.

To exclude your e-mail address when replying to all

When you reply to all the recipients of an Outlook e-mail, your own e-mail address will also be added to the recipient list. Customize ActiveSync so that your e-mail address(es) will be excluded from the recipient list.

1. In ActiveSync on your phone, select **Menu > Options**.
2. Select the **E-mail** information type and then select **Settings**.
3. Select **Menu > Advanced**.
4. In the **My e-mail addresses** text box, enter the e-mail address(es). If you want to enter more than one, separate the e-mail addresses with a semicolon.
5. Select **Done**.

6.8 Use Keyboard Shortcuts

You can use keyboard shortcuts to quickly access messaging functions, such as reply, forward, etc.

To see the list of keyboard shortcuts

1. Select **Start > Messaging** and select a messaging account (Text/Multimedia or any e-mail account).
2. While on a message list, press any key.
3. If this is your first time using keyboard shortcuts, a Message Tips screen will appear first:

Select **OK** to close the screen.

4. Press and hold the “0” key until the shortcuts list is displayed. Scroll up or down to view the whole list.

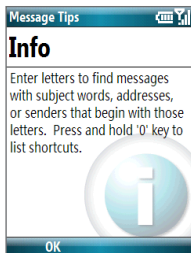

To use a keyboard shortcut

Press and hold the respective key. For instance, to reply to a message, press and hold **2**.

Chapter 7

Working with Company E-mails and Meeting Appointments

7.1 Synchronizing Your Phone with the Exchange Server

7.2 Working with Company E-mails

7.3 Managing Meeting Requests

7.4 Finding Contacts in the Company Directory

7.5 E-mail Security

7.1 Synchronizing Your Phone with the Exchange Server

To keep up-to-date with your company e-mails and meeting schedules while you're out of the office, you can connect your phone to the Internet wirelessly and synchronize this information with your company's Exchange Server. You can also access your company address book anytime. Your company must have a mail server that is running Microsoft Exchange Server with Exchange ActiveSync.

Before you can start to synchronize with or access information from the Exchange Server, you need to set up an Exchange Server connection on your phone. You need to get the following information from your network administrator and enter it on your phone:

- Exchange Server name (must be the Outlook Web Access server name)
- Domain name that you use at work
- User name and password that you use at work

You can set up the Exchange Server connection from your phone or your PC.

Set up an Exchange Server connection from your phone

If you have not synchronized your phone with your PC, follow these steps to set up an Exchange Server connection.

1. On the Home screen, scroll down to  on the Shortcut Bar and then select **Set Up E-mail**.
2. On the Select Account screen, select **Outlook** and then select **Next**.
3. On the ActiveSync screen, select **set up your device to sync with it**.

Note Skip this step if you have previously created an ActiveSync® partnership between your phone and PC.

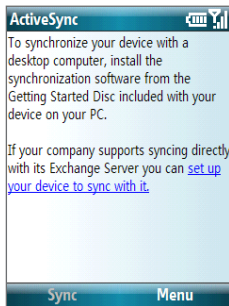

4. Enter your e-mail address. Clear the **Attempt to detect Exchange Server settings automatically** check box, then select **Next**.

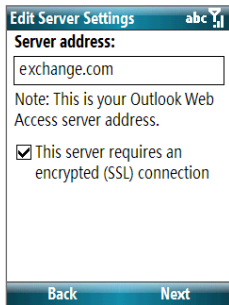
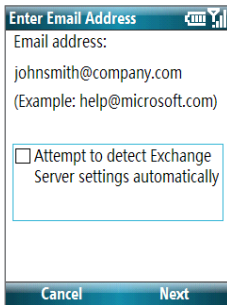

5. Enter the server address and select **This server requires an encrypted (SSL) connection** if necessary, then select **Next**.

5. Enter your user name, password, and domain, and then select **Next**.
6. Select the check boxes for the types of information items that you want to synchronize with the Exchange Server.

Tip To change the rules for resolving synchronization conflicts, select **Menu > Advanced**.

7. To change synchronization settings of an information type (for example, E-mail), select the type of information and then select **Menu > Settings**.
8. Select **Finish**.

Note If you synchronized e-mails with your PC before, open ActiveSync on your phone and select **Menu > Add Server Source** to set up an Exchange Server connection. When you're prompted to select information types for synchronization, you need to clear the **E-mail** check box under the Windows PC item first before you can select the **E-mail** check box under Exchange Server.

Tip To change Exchange Server settings, open ActiveSync on your phone and select **Menu > Configure Server**.

Set up an Exchange Server connection from your PC

On a Windows Vista PC

1. Set up synchronization between your PC and phone. See "Set up synchronization in Windows Mobile® Device Center" in Chapter 3 for details.
2. Click **Start > All Programs > Windows Mobile Device Center** on your PC.
3. On Windows Mobile® Device Center's Home screen, mouse over **Mobile Device Settings**, click **> more**, and then click **Sync wirelessly with Exchange Server**.



4. Enter your company's Exchange Server address, your **User name**, **Password**, and **Domain**.
5. Click **Set Up**.

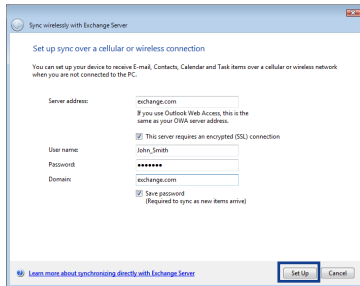

6. On Windows Mobile® Device Center's Home screen, click **Change content sync settings**.
7. Select the check box of items you want to synchronize with the Exchange Server. Under the e-mail setting, click **Sync Settings** to choose synchronization settings for the selected items and then click **Save**.

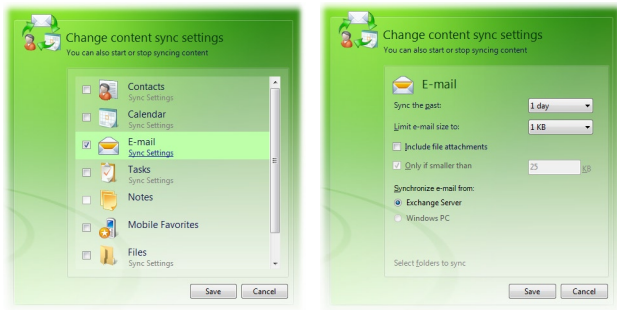

On a Windows XP PC

1. Install Microsoft ActiveSync® on your PC if you have not yet done so. See “Install ActiveSync” in Chapter 3 for details.
2. Connect your phone to the PC.
3. If you have not set up synchronization with your PC before, follow the steps in “Set up synchronization in ActiveSync” in Chapter 3 and make sure to select the **Synchronize directly with a server running Microsoft Exchange** option in the Synchronization Setup Wizard.

4. If you have synchronized your phone with your PC before, do the following steps to set up synchronization with the Exchange Server:
 - a. Right-click the ActiveSync icon (🔄) at the bottom right side of your PC, then click **Open Microsoft ActiveSync**.
 - b. In ActiveSync on your PC, click **Tools > Add Server Source**, enter your company's Exchange Server address, your **User name**, **Password**, and **Domain**, and then click **OK**.

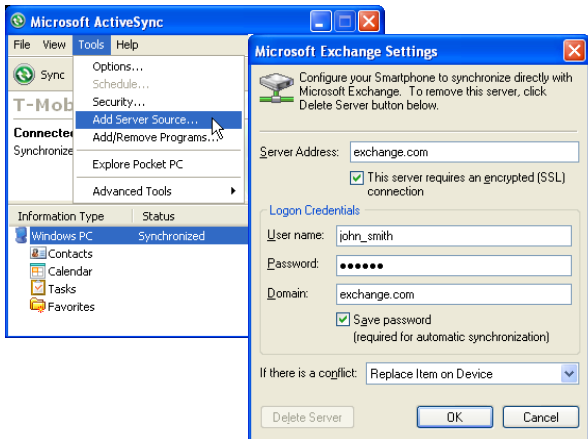

- c. Choose the items to be synchronized and other settings in the **Options**, **Schedule** and **Security** tabs, and then click **OK**.

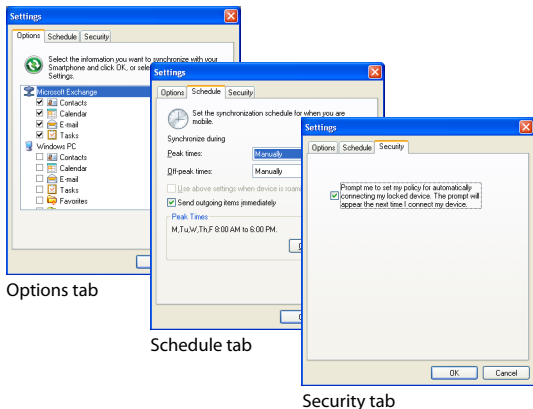

Options tab

Schedule tab

Security tab

Start synchronization

Before you start synchronizing with the Exchange Server, make sure your phone has been set up with a data connection to the Internet so that you can synchronize wirelessly. For more information about connecting to the Internet, see Chapter 8.

After you finish setting up an Exchange Server connection, your phone automatically starts synchronization.

You can manually start synchronization anytime by selecting **Sync** in ActiveSync.

Notes

- You need a T-Mobile data plan to be able to synchronize with the Exchange Server.
- If you connect your phone to your office computer via a USB or Bluetooth connection, you can use this connection to the PC to “pass through” to the network and download Outlook e-mails and other information to your phone.

7.2 Working with Company E-mails

Your phone gives you instant access to your company e-mails and lets you manage your messages more easily. Messaging features, such as Direct Push, Fetch Mail, and Filtering messages, are just some of the tools you can use in managing your e-mails.

Note Some messaging features depend on the Microsoft Exchange Server version used. Please check with your network administrator for the availability of Exchange Server features.



Automatic synchronization through Direct Push

Direct Push technology (push e-mail feature) enables you to receive new e-mails on your phone as soon as they arrive in your Inbox on the Exchange Server. With this feature, items such as contacts, calendar, and tasks are also immediately updated onto your phone when these items have been changed or new entries have been added on the Exchange Server. To make Direct Push work, you need to have a GPRS connection on your phone.

You need to perform a full synchronization between your phone and the Exchange Server first before you can enable Direct Push.

Requirement Windows Mobile® 6.1 features Direct Push version 2.0, which is redesigned to give you better bandwidth and battery performance. Direct Push version 2 reduces bandwidth usage by up to 60% and improves battery life by an average of 33%. For Direct Push version 2.0, **Microsoft Exchange Server 2007 Service Pack 1 (SP1) with Exchange ActiveSync or higher version** is required.

To enable Direct Push via Comm Manager

1. On the Home screen, scroll down to  on the Shortcut Bar and then select **Manage Connections**.
2. On the Comm Manager screen, select the **DirectPush** button. The button  will turn to , which indicates that you will receive e-mails as they arrive.

When the button is in the  state, you need to manually retrieve your e-mails.

Note The option you set here will override the options you have set in ActiveSync.

To enable Direct Push via ActiveSync

1. In ActiveSync on your phone, select **Menu > Schedule**.
2. Select **As items arrive** in the **Peak times** and **Off-peak times** boxes.

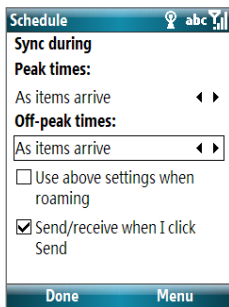
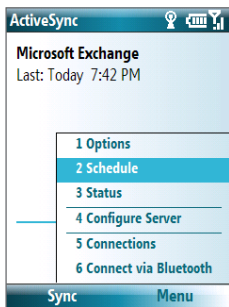

Note When both the GPRS/EDGE and Wi-Fi connections are turned on at the same time, the Direct Push feature will always opt for GPRS/EDGE, which you could be charged for based on your T-Mobile service plan.

Scheduled synchronization

If you do not want to use Direct Push, you can set a regular schedule for synchronizing Outlook e-mail and information.

1. In ActiveSync on your phone, select **Menu > Schedule**.
2. Select a shorter time interval in the **Peak times** box for you to be able to receive e-mails more frequently.
3. Select a longer interval in the **Off-peak times** box.

Tip Select **Menu > Peak Times** to set the peak and off-peak times.

Instant download through Fetch Mail

Fetch Mail downloads an entire e-mail immediately without the need for you to perform a full Send/Receive action.

Requirement Fetch Mail works for your phone only if your company is using **Microsoft Exchange Server 2007 or higher**.

1. On the Home screen, scroll down to  on the Shortcut Bar and then select **Outlook E-mail**.
2. Select an e-mail message to open it.
3. By default, only the first few kilobytes of the message displays. To download the whole e-mail, scroll to the bottom of the message and then select **Get the rest of this message**.
4. A "Downloading message" status appears. Wait for the remainder of the message body to download.

Tip For information about changing e-mail sync options such as the initial download size limit for e-mail, see "Customize e-mail settings" in Chapter 6.

Search for e-mails on the Exchange Server

You can access messages that are not available on your phone by searching your Microsoft Exchange Server mailbox. The search results will be downloaded and displayed in a Search Results folder.

Requirement Your company must be using **Microsoft Exchange Server 2007 or higher**.

1. On the Home screen, scroll down to  on the Shortcut Bar and then select **Outlook E-mail**.
2. Select **Menu > Tools > Search Server**.
3. In the **Look for** text box, enter the search keyword.
4. Choose the **Date range** of messages to search from and **Look in** for where to search.
5. Select **Search**.

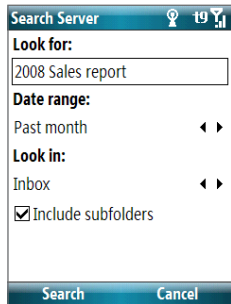

Flag your messages

Flags serve as a reminder for you to follow up on important issues or requests that are indicated in the messages.

Requirement Flags are enabled only if e-mails are synchronized with **Microsoft Exchange Server 2007 or higher**. Flags are disabled or hidden if e-mails are synchronized with earlier versions of Microsoft Exchange Server.

To flag or unflag a message

1. On the Home screen, scroll down to  on the Shortcut Bar and then select **Outlook E-mail**.
2. Select or open a message.
3. Select **Menu > Follow Up** and then select one of the following options:
 - **Set Flag** Mark the message with a red flag to indicate that it needs follow up.
 - **Complete Flag** Mark the message with a check mark to indicate that the issue or request in the e-mail is already completed.
 - **Clear Flag** Remove the flag to unmark the message.

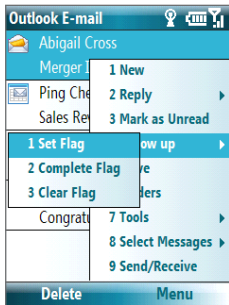

Note E-mail message reminders will display on your phone if the messages are flagged with reminders and synchronized from the Exchange Server.

Out-of-office auto-reply

Outlook Mobile® lets you retrieve and change your out-of-office status. Just like desktop Outlook E-mail, Outlook Mobile® automatically sends an auto-reply message when you're not available.

Requirement Your company must be using **Microsoft Exchange Server 2007 or higher**.

To send out-of-office auto-reply messages

1. On the Home screen, scroll down to  on the Shortcut Bar and then select **Outlook E-mail**.
2. Select **Menu > Tools > Out of Office**.
3. From the **I am currently** list, select **Out of the Office**.
4. Enter your auto-reply message and then select **Done**.

View a document linked to an e-mail message

When you receive an e-mail that contains a link to a document such as a PDF or Microsoft® Office document located on SharePoint or an internal file server, you can view the document on your phone.

Requirement You can view the document only if you have a Microsoft Outlook account that synchronizes with **Microsoft Exchange Server 2007 or later**. Exchange Server must also be set up to allow access to SharePoint document libraries or internal file servers.

1. On the Home screen, select **Start > Messaging**.
2. Select an e-mail account and then open a message with a link to a SharePoint document.
3. Select the link to open and then view the document.

7.3 Managing Meeting Requests

When you schedule and send meeting requests from your phone, you can invite attendees to your meeting and check their status to know their availability.

When you receive a meeting request, you can reply by accepting or declining the request. The meeting request also clearly indicates whether there are conflicting or adjacent meetings.

Note You can still accept and respond to meeting requests on your phone if your company is using an earlier version of Microsoft Exchange Server, but some features will not be enabled. To use the features mentioned in this section, your company must be using **Microsoft Exchange Server 2007 or higher**.

To reply to a meeting request

1. When an incoming e-mail has a meeting request, a notification message will be displayed on your phone's Home screen. Scroll down to  on the Shortcut Bar and then select **Outlook E-mail**.
2. In the Outlook message list, select the e-mail to open it.
3. Select **Accept** to reply and accept the meeting request, or select **Menu > Decline** if you cannot attend the meeting.

Tips

- Before responding, you can check your availability during the time of the requested meeting by selecting **View your calendar**.
 - If the meeting time conflicts with your other appointments, a "Scheduling Conflict" status appears on top of the e-mail.
4. Choose whether or not to edit the response e-mail before sending and then select **OK**.

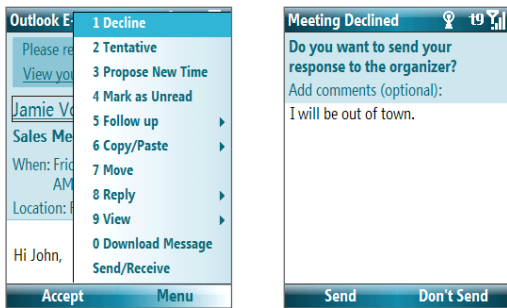

5. If you accepted the meeting request, it will automatically be added as an appointment in your phone Calendar.

To view the list of meeting participants

1. Select **Start > Calendar**.
2. Open a meeting request that you previously sent and then select **Attendees**. The list of required and optional attendees displays.

Notes

- For information about creating a meeting request, see “To send a meeting request” in Chapter 5.
- If you select a meeting that you have organized, the list shows who has accepted or declined the meeting.
- To view an attendee's contact information, select the attendee's name. If the attendee is included in your contacts list, you will see the contact information immediately. If the attendee is not in your contacts list, select **Company Directory** to view the contact information.

7.4 Finding Contacts in the Company Directory

Besides having contacts on your phone, you can access contact information from your organization's Company Directory.

Requirement Access to the Company Directory is available only if your organization is running **Microsoft Exchange Server 2003 SP2 or higher**, and you have completed your first synchronization with the Exchange Server.

1. Synchronize with Exchange Server if you have never done so.
2. Do any of the following:
 - In Contacts, select **Menu > Company Directory**.
 - In a new e-mail, select the **To** box and then select **Company Directory** at the top of the list or select **Menu > Company Directory**.
 - In a new meeting request using Calendar, scroll to **Attendees** and select **No attendees > Add Required Attendee** or **Add Optional Attendee** and then select **Company Directory** at the top of the list.

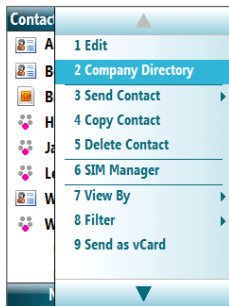

In Contacts

3. Enter the part or full contact name and then select **Search**. In the search results list, select the desired contact.

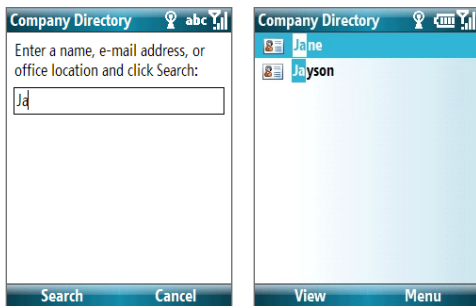

Notes

- You can save the contact from the Company Directory to your phone by selecting the contact and then selecting **Menu > Save to Contacts**.
- You can search on the following information as long as that information is included in your organization's Company Directory: First name, Last name, E-mail name, Display name, E-mail address, or Office location.

7.5 E-mail Security

Windows Mobile® on your phone protects your Outlook e-mails through Secure/Multipurpose Internet Mail Extension (S/MIME), which lets you digitally sign and encrypt your messages.

Requirement S/MIME encryption and digital signatures for Windows Mobile® powered smartphones are available only with **Exchange Server 2003 SP2 or a later version** that supports S/MIME. If you are not using one of these products or have not yet synchronized, these options are unavailable.

Note You can encrypt a message with or without a certificate. However, to read an encrypted message, you need a valid certificate to decrypt it.

Encrypt and sign messages

To individually sign and encrypt a new message

1. On the Home screen, scroll down to  on the Shortcut Bar and then select **Outlook E-mail > Compose**.
2. Select **Menu > Message Options**.
3. From the **Security** list, select whether to encrypt only, sign the message only, or do both.
4. Select **Done**.

To verify the digital signature on a signed message you receive

1. Open the Outlook e-mail message that has been digitally signed.
2. At the top of the message, select **View signature status**.

Note You may need to download the rest of the message to see the name of the person who signed the e-mail.

3. Select **Menu > Check Certificate**.

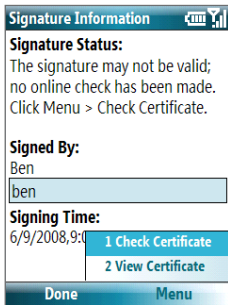
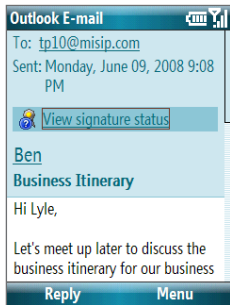

To view the details of the certificate in the message, select **Menu > View Certificate**.

Note There can be several reasons why a digital signature is not valid. For example, the sender's certificate may have expired, it may have been revoked by the certificate authority, or the server that verifies the certificate is unavailable. Contact the sender to report the problem.

To digitally sign and encrypt all messages

You can set up ActiveSync to digitally sign and encrypt all outgoing messages. You must obtain a valid certificate to sign and encrypt e-mail messages successfully.

1. Select **Start > Applications > ActiveSync**.
2. Select **Menu > Options**.
3. Select the **E-mail**

information type and then select **Settings**. On the E-mail Sync Options screen, select **Menu > Advanced**.

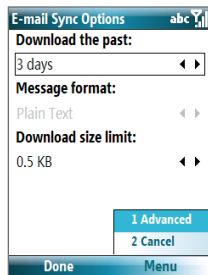
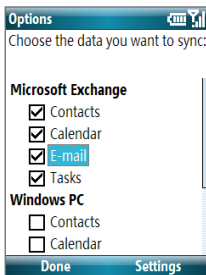

4. Select **Encrypt messages** to protect your e-mails from being viewed except by the intended recipients.
5. Select **Sign messages** so that recipients are certain that e-mails are sent by you and have not been altered.
6. Select **Menu > Choose Certificate** to select a certificate for signing or encrypting outgoing e-mail messages.

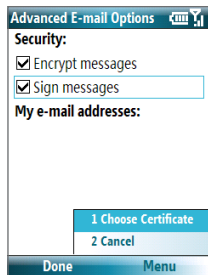

Set permissions on an e-mail message

Another way of protecting your e-mail messages is to send messages with restricted permissions using Information Rights Management (IRM).

Requirement This works only with a Microsoft Outlook e-mail account and if your company is using RMS Server SP1.

1. Select **Start > Messaging > Outlook E-mail**.
2. Create a message and then select **Menu > Message Options**.
3. In **Permissions**, do one of the following:
 - Select **Unrestricted Access** to let anyone read the message.
 - Select **Do Not Forward** to prevent the message from being forwarded, printed, or copied.
4. Select **Done**.

Tip An IRM-protected message received on your phone can only be replied to or forwarded if the message permits it.

Chapter 8

Getting Connected

- 8.1 Comm Manager
- 8.2 Ways of Connecting to the Internet
 - 8.3 Wi-Fi
 - 8.4 GPRS/EDGE
 - 8.5 Dial-up and Others
 - 8.6 Internet Explorer® Mobile
- 8.7 Using Your Phone as a Modem (Internet Sharing)
 - 8.8 Bluetooth
 - 8.9 Windows Live™
- 8.10 Windows Live™ Messenger
- 8.11 Windows Live™ Search

8.1 Comm Manager

Comm Manager acts like a central switch that lets you enable or disable phone features as well as easily manage your data connections.

To open Comm Manager:

On the Home screen, scroll down to  on the Shortcut Bar, and then select **Manage Connections**.

- 1 Select to enable or disable the phone. Select **Settings > Phone** to access phone settings.
- 2 Select to toggle between turning on or off Bluetooth. See “Bluetooth” for details. Select **Settings > Bluetooth** to configure Bluetooth on your phone.
- 3 Select to toggle between turning on or off Wi-Fi. Select **Settings > Wi-Fi** to configure Wi-Fi on your phone. See “Wi-Fi” for details.
- 4 Select to toggle between automatically receiving (as items arrive) or manually retrieving Outlook e-mails. See Chapter 7 for details. Disabling this feature will override the options you have set for your synchronization schedule.
- 5 Select to disconnect active data connections (e.g. GPRS/EDGE). You cannot reconnect a data connection in Comm Manager.

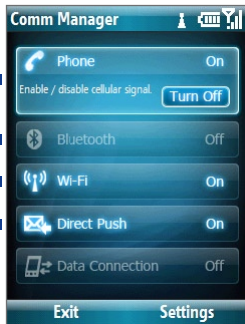

8.2 Ways of Connecting to the Internet

Your phone's networking capabilities let you access the Internet or your corporate network at work through wireless and conventional connections.

You can connect to the Internet by using one of the following:

- Wi-Fi
- GPRS or EDGE
- Dial-up

Note You can also add and set up the following connections:

- **VPN:** A VPN connection is used to access your corporate network by using an existing Internet connection.
- **Proxy:** A Proxy connection is used to access the Internet using an existing connection to your corporate or WAP network.

8.3 Wi-Fi

Wi-Fi provides wireless Internet access over distances of up to 300 feet. To use Wi-Fi on your device, you need access to a wireless access point or “hotspot”.

Note The availability and range of your phone's Wi-Fi signal depends on the number, infrastructure, and other objects through which the signal passes.

Connect to T-Mobile HotSpot

T-Mobile HotSpot gives you wireless access to the Internet over the T-Mobile Wi-Fi network in convenient locations across the U.S., such as airports, coffee shops, bookstores, hotels, and more. It is great for e-mail, Web browsing, and other high-bandwidth applications.

Contact T-Mobile to add T-Mobile HotSpot service to your data plan. Visit www.t-mobile.com or a T-Mobile store for plan information.

Your device can automatically log you into T-Mobile's wireless network whenever you visit a T-Mobile HotSpot.

Note You do not need to add T-Mobile HotSpot service for Wi-Fi calling in T-Mobile HotSpot locations. If you do not have a T-Mobile HotSpot account, you can turn off this utility by selecting **Start > Wi-Fi > HotSpot Settings** and checking **Disable HotSpot Login Utility**.

To log in to T-Mobile HotSpot



1. Select **Start > Wi-Fi > HotSpot Settings**.

Note An Info Message appears the first time Wi-Fi is on in a HotSpot. To see this message again, select **Menu > Tips..**

2. Type in your T-Mobile HotSpot **Username** and **Password** and select **OK**.

Simply turn on Wi-Fi from Comm Manager when you are in a T-Mobile HotSpot, and you will be connected.

When logging into a T-Mobile HotSpot with Wi-Fi turned on, you will see  (this means it is trying to connect) on top of the Home screen. Once you successfully log in to the T-Mobile HotSpot, you will see a confirmation screen.

The  icon on the Home screen changes to  when you are successfully logged in.

To log off from T-Mobile HotSpot

1. Select **Start > Wi-Fi > HotSpot Status**.
2. Select **Logoff**.

Notes

- If you have attempted to login and see  on the Home screen, there has been an error in your login. Select **Start > Wi-Fi > HotSpot Status** to display the status of your login attempt.
- If you do not have a T-Mobile HotSpot account, you can turn off this utility by selecting **Start > Wi-Fi > HotSpot Settings** and checking **Disable HotSpot Login Utility**.

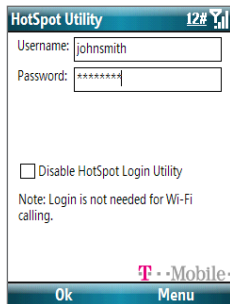

To change the HotSpot Utility settings

The HotSpot Utility automates the login process when you are in a T-Mobile HotSpot.

1. Select **Start > Wi-Fi > HotSpot Settings**.
2. Select **Menu > Advanced Settings**.
3. Select or clear the options you want.
 - **Skip 'login/cancel/sign up' request:** If not selected, the HotSpot Found screen will be displayed first for you to log in (if Username and Password are not correctly filled in). If you want to get a T-Mobile HotSpot account, select **Sign up for T-Mobile HotSpot service**.
 - **Automatic login:** If not selected, you will be prompted to type in your username and password whenever you turn on Wi-Fi and try to connect to T-Mobile HotSpot.
 - **Automatic logoff:** If not selected, a message will always display first to confirm whether you want to log off from the T-Mobile HotSpot service.
 - **Disable HotSpot Login Utility:** If selected, you will not be prompted to connect when you are in a T-Mobile HotSpot location. To connect, clear this check box.
4. Select **OK**.

To reset HotSpot Utility settings

1. Select **Start > Wi-Fi > HotSpot Settings**.
2. Select **Menu > Reset All**.

Note The Username and Password fields will also be cleared.

To find a T-Mobile HotSpot location

1. Connect to the Internet using Wi-Fi, GRPS/EDGE, or dial-up.
2. On the Home screen, scroll down to  on the Shortcut Bar, and then select **Browse Web**.
3. Select **Menu > Favorites > HotSpot locator** and select **Go**.

Note You may need to press one of the SOFT KEYS to show **Menu**.

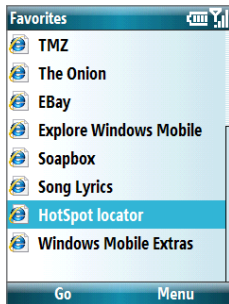

4. Enter or type in the search criteria and then select **Submit** on the page.

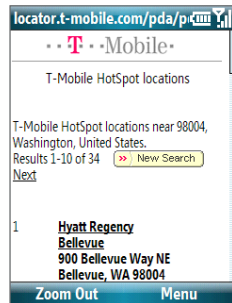
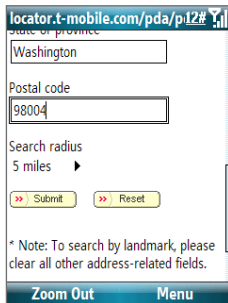
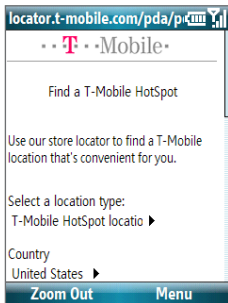

About UMA

Your device features UMA (Unlicensed Mobile Access) capability. UMA is the commercial name of the 3GPP Generic Access Network (GAN standard). GAN extends mobile services voice, data and IP applications over IP access networks. With UMA enabled, you can seamlessly roam between GSM and UMA networks, and the device will handover the signal.

When UMA is enabled and you are in a UMA service area, you will be able to use GSM/GPRS services via a Wi-Fi or IP network. The UMA client handles handover between random access networks and UMA networks automatically.

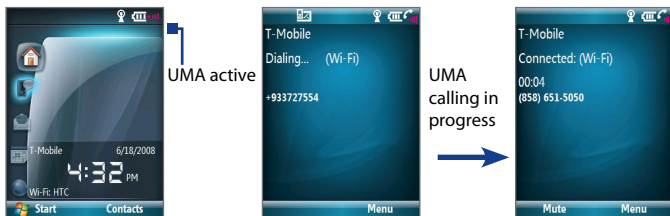



UMA modes

Phone on	Wi-Fi on	Phone and Wi-Fi on
GSM only	UMA only	UMA / GSM (preferred mode)



Connect to other wireless networks

To create a connection to an existing Wi-Fi network

1. On the Home screen, scroll down to  on the Shortcut Bar, and then select **Manage Connections**.

- On the Comm Manager screen, select the **Wi-Fi** icon and then press **CENTER SELECT**. The Wi-Fi icon changes to  to indicate that Wi-Fi is turned on.
- Select **Settings > Wi-Fi**. The Wi-Fi Manager opens.
- Select **Available Networks**. After a few seconds a list of available networks is displayed.
- Press **NAVIGATION WHEEL** up or down to choose the Wi-Fi network to connect to.
- Press **CENTER SELECT**.
- If you are connecting to a security-enabled network, you will be asked to enter the Network Key (WEP, WPA-PSK, WPA2, etc.) Enter the Network Key and then select **Finish**.

If the network isn't listed in **Saved Networks**, you are prompted to save the network.

- Select **Save** to save the network profile to Saved Networks. Select **Menu > Done** to finish without saving. A checkmark  (or  when it is a UMA network) next to the network name indicates that the network is connected.

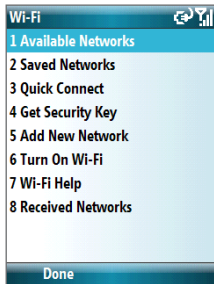

Wi-Fi Manager

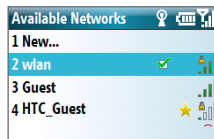

Normal Wi-Fi Network



UMA Network

Notes

- You can check the Wi-Fi icon on the Title bar of the screen to see if you are connected to the Wi-Fi network. To see the status icons, see “Status Indicators” in Chapter 1.
- Wi-Fi connects to the default network that is available on your phone. However, GPRS/EDGE starts by default if your phone does not detect any Wi-Fi signal.
- In Comm Manager, select **Settings > Wi-Fi > Available Networks** to check the current connection status and signal quality of each Wi-Fi channel.
- To refresh the available network list, select **Menu > Refresh**.
- To view details on a network, select **Menu > View Detail**.

To create a new Wi-Fi connection

If the Wi-Fi connection you want to connect to is not in the list, you can create a new Wi-Fi connection.



1. On the Home screen, scroll down to  on the Shortcut Bar, and then select **Manage Connections**.
2. Select **Settings > Wi-Fi**. The Wi-Fi Manager opens.
3. Select **Add New Network > Create Manually**.
4. Enter the **SSID** (Service Set Identifier) and select the **Network type**.
5. Select **Next**.
6. Select the **Authentication** type and **Data encryption**.
Default settings are: **Authentication** = Open ; **Data Encryption** = WEP
For TKIP, AES, or WEP data encryption, enter the needed information in the remaining fields and then select **Next**.
7. Select **Use IEEE 802.11x network access control** to use Extensible Authentication Protocol (EAP).
8. Select the **EAP type** depending on the type of authentication and then select **Finish**.
9. Enter a Profile Name if desired and select **Save**. The connection is saved to **Saved Networks**.

To save a network to Saved Networks

You can save preferred network profiles to Saved Networks.

1. On the Home screen, scroll down to  on the Shortcut Bar, and then select **Manage Connections**.
2. Select **Settings > Wi-Fi**. The Wi-Fi Manager opens.
3. Select **Available Networks**. After a few seconds a list of available networks is displayed.
4. Choose the network you want to save from the list and select **Menu > Save**.
5. Change the Profile Name if desired and select the **Network Type**.
6. Select **Next**.
7. Select the **Authentication** type and **Data encryption**.
Default settings are: **Authentication** = Open ; **Data Encryption** = WEP
For TKIP, AES, or WEP data encryption, enter the needed information in the remaining fields and then select **Next**.
8. Select **Use IEEE 802.11x network access control** to use Extensible Authentication Protocol (EAP).
9. Select the **EAP type** depending on the type of authentication and then select **Finish**.

Notes

- Saved network profiles listed in **Available Networks** are marked by a gold star.
- To delete a saved network, on the Saved Networks screen select **Menu > Delete**.
- A checkmark  (or  when it is a UMA network) next to the network name indicates that the network is connected.

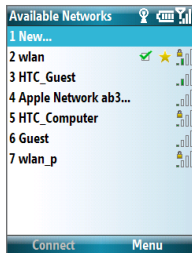

To change the priority of a saved network

You can change the priority of a network in the Saved Networks screen. When Wi-Fi is on, the device attempts to connect to the networks in the list in the order of their priority.

1. Tap **Menu > Change Priority**.
2. Select where to move the network from the menu.

Note **HotSpot** and **@Home** are T-Mobile profiles provided for connection with T-Mobile HotSpots and T-Mobile @Home wireless routers, respectively. You can change the priority of these profiles; however, they cannot be deleted.

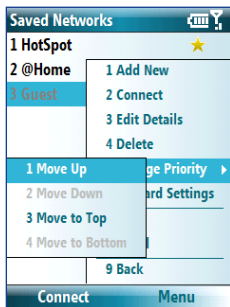

To increase security on the Wi-Fi network

The LEAP (Lightweight Extensible Authentication Protocol) feature of Comm Manager helps increase security on your phone, and ensures that nobody can access your network without your permission.

1. On the Wi-Fi Manager screen, select **Saved Networks**.
2. Select **Menu > LEAP**.
3. Select **Menu > New**.

Note By default, the LEAP screen displays data that you entered previously. However, you can modify or delete the data as required by selecting **Menu > Modify** or **Menu > Delete** on the LEAP screen.

4. Enter the **SSID** (Service Set Identifier). You can obtain this information from T-Mobile.
5. Enter the domain, user name, and password.

6. Select an **Authentication Type**. By default, the **Authentication Type** for your phone is **Open System** authentication.

Note For LEAP to work correctly, the receiving phone (your phone) must be set with the same SSID, user name, and password as the access point.

To forward saved network settings

You can send network profile settings to another phone to enable it to connect to that network.

1. On the Wi-Fi Manager screen, select **Saved Networks**.
2. Select a saved network and then select **Menu > Forward Settings**.
3. Enter the phone number directly or select **Menu > Contacts** to add a number from Contacts. You can add up to six numbers.
4. Select **Send**. After a moment, a message appears saying that the settings were sent.
5. The receiving phone gets a message that Wi-Fi security settings have been sent.
 - Select **View** to view and then save the network to **Saved Networks**.
 - Select **Cancel** to save the message with the settings to **Received Networks**.

Note You can view networks that have been sent to your phone. On the Wi-Fi Manager screen, select **Received Networks**.

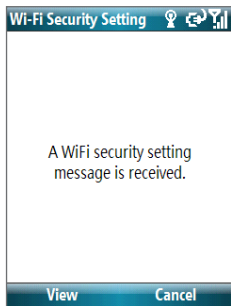

To quickly connect to the Internet

You can use Quick Connect to automatically connect to the Internet.

1. On the Home screen, scroll down to  on the Shortcut Bar, and then select **Manage Connections**.
2. Select **Settings > Wi-Fi**. The Wi-Fi Manager opens.
3. Select **Quick Connect**.

Quick Connect will turn on the Wi-Fi and connect to an available network with the strongest signal or to an open network.

Note If a Wi-Fi session is already active, a message will display saying that the device is already connected.

4. Select **Done**.

Tip Press and hold the **SHORTCUT KEY** on the side of the device to activate Quick Connect.

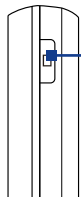

Press and hold
to activate Quick
Connect

To get security settings and Wi-Fi profile from a T-Mobile wireless router

You can enable the phone to automatically retrieve security and Wi-Fi settings from a T-Mobile wireless router.

On the Wi-Fi Manager screen, select **Get Security Key** and follow the onscreen prompts.

8.4 GPRS/EDGE

You can use GPRS/EDGE to connect to the Internet or to send and receive Picture Messages on your phone. You need a data plan to access the T-Mobile GPRS/EDGE network.

Note T-Mobile GPRS/EDGE settings are already preconfigured and modifying them may cause services to stop working.

To set up a new GPRS/EDGE connection

If GPRS/EDGE settings are not preset on your phone or are accidentally deleted, obtain the **Access point name** from T-Mobile. Also, check with T-Mobile if a user name and password are required.

1. On the Home screen, select **Start > Settings > Connections > GPRS > New**.
2. In **Description**, enter a name for the connection.
3. In **Connects to**, select **The Internet**.
4. Enter the name of the T-Mobile **Access point**.
5. Enter the appropriate information in the remaining fields, if required by T-Mobile, and then select **Done**.

Add GPRS abc

Description:
GPRS

Connects to:
The Internet

Access point:
accesspoint

User name:

Password:

Done Cancel

8.5 Dial-up and Others

When you use your phone to dial your ISP and connect to the Internet or to your corporate network, you will be billed by the number of minutes that you use.

To set up a dial-up connection for browsing the Internet

1. On the Home screen, select **Start > Settings > Connections > Dial-up > New**.
2. In **Description**, enter a name for the connection.
3. In **Connects to**, select **The Internet**.
4. Enter the appropriate information in the remaining fields.
5. Select **Done**.

To set up a dial-up connection to your corporate network

1. On the Home screen, select **Start > Settings > Connections > Dial-up > New**.
2. In **Description**, enter a name for the connection.
3. In **Connects to**, select **Work**.
4. Enter the appropriate information in the remaining fields.
5. Select **Done**.

To add a URL exception

Some URLs for Web pages on your company intranet may use periods, for example: intranet.companyname.com. To view these pages in Internet Explorer® Mobile, you must create a URL exception.

1. On the Home screen, select **Start > Settings > Connections > Menu > Advanced**.
2. Select **Menu > Work URL Exceptions > Menu > Add**.
3. In **URL Pattern**, enter the URL name. To add multiple URLs, use a semicolon (;).
4. Select **Done**.

Note You do not need to create URL exceptions for Internet URLs.

Advanced options

From the Connections screen, you can access advanced options to specify the service provider, the number of redial attempts, the amount of idle time to wait before disconnecting, and so on.

1. On the Home screen, select **Start > Settings > Connections > Menu > Advanced**.
2. Select a network service provider for each connection type. You can choose **Automatic** to let the phone set a service provider for each connection by default.
3. Select **Menu > Options**.
4. Choose the appropriate information in the remaining fields.
5. Select **Done**.

8.6 Internet Explorer® Mobile

Internet Explorer® Mobile is a full-featured Internet browser, optimized for use on your phone.

To open Internet Explorer Mobile

On the Home screen, scroll down to  on the Shortcut Bar and then select **Browse Web**.

Browse the Web

1. In Internet Explorer® Mobile, do one of the following:
 - In the Search bar, enter the keyword to use for searching information on the Web and then select .
 - Select **Menu > Address Bar**, enter the Web page address, and then select **Go**.
2. Use the **NAVIGATION WHEEL** to browse the Web page. Press **CENTER SELECT** to access a highlighted link.

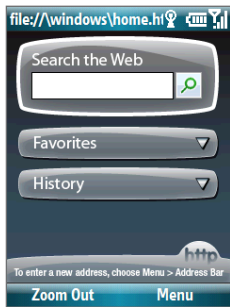

While browsing the Web, select **Menu** to open a list of options that will let you change the view, save Favorites, and set Internet Explorer® Mobile preferences, and more.

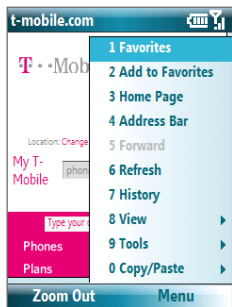

Select **Menu > Add to Favorites** to save the current Web page in your Favorites folder. Select **Favorites** to access your Favorites folder.

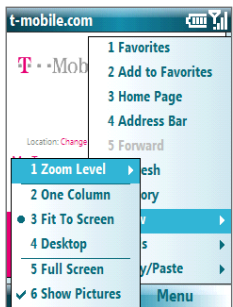

Select **Menu > View** and then select the zoom level and type of view you want to use while browsing a Web page.

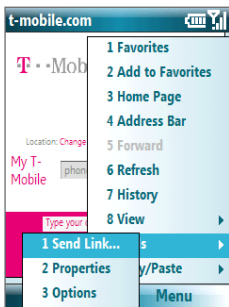

Select **Menu > Tools** to send the link via e-mail, view the page's properties, or set Internet Explorer® Mobile preferences.

For more information about Internet Explorer® Mobile, visit:
<http://www.microsoft.com/windowsmobile/help/smartphone/browseinternet.mspx>

8.7 Using Your Phone as a Modem (Internet Sharing)

With **Internet Sharing**, you can use your phone as an external modem for another device such as a PDA or notebook computer.

Notes

- Make sure your phone has a SIM card installed, and your phone has a GPRS/EDGE or phone dial-up modem connection. If your phone has not been set up with a data connection yet, select **Menu > Connection Settings** on the Internet Sharing screen. For more information about setting up a GPRS/EDGE connection, see "GPRS/EDGE". For more information about setting up a phone dial-up connection, see "Dial-up and Others".
- Before using Internet Sharing, disconnect your phone from Windows Mobile® Device Center or ActiveSync®. In Windows Mobile® Device Center, mouse over **Mobile Device Settings**, click **Connection settings**, and then clear the **Allow USB connections** check box. In ActiveSync on your PC, click **File > Connection Settings** and then clear **Allow USB connections**.

To set up the phone as a USB modem

1. On your phone, select **Start > Device Management > Internet Sharing**.
2. In the **PC Connection** list, select **USB**.
3. In the **Network Connection** list, select the name of the connection that your phone uses to connect to the Internet.
4. Plug in the USB cable between your phone and the computer.
5. Select **Connect**.

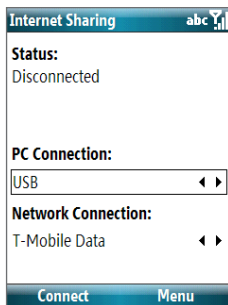

To set up the phone as a Bluetooth modem

1. On your phone, turn on Bluetooth and set it to **Visible** mode by following the steps in “To turn on or off Bluetooth on your phone”.
2. Initiate a Bluetooth partnership from your phone by following the steps in “To create a Bluetooth partnership.”
3. Select **Start > Device Management > Internet Sharing**.
4. Select **Bluetooth PAN** as the **PC Connection**.
5. From the **Network Connection** list, select the name of the connection that your phone uses to connect to the Internet.
6. Select **Connect**.
7. On your computer, set up a Bluetooth Personal Area Network (PAN) with your phone:

For Windows Vista:

- a. Click **Start > Control Panel > Network and Sharing Center**.
- b. Click **Manage network connections**.
- c. Under **Personal Area Network**, double-click **Bluetooth Network Connection**.
- d. In the Bluetooth Personal Area Network Devices dialog box, select your phone and then click **Connect**.

For Windows XP:

- a. Click **Start > Control Panel > Network Connections**.
- b. Under **Personal Area Network**, click the **Bluetooth Network Connection** icon.
- c. Under **Network Tasks**, click **View Bluetooth network devices**.
- d. In the Bluetooth Personal Area Network Devices dialog box, select your phone and then click **Connect**.

8. On the Internet Sharing screen on your phone, check if a connected status is displayed, which indicates that your computer has been successfully connected to the Internet using your phone as a Bluetooth modem.

To end the Internet connection

On the Internet Sharing screen, select **Disconnect**.

8.8 Bluetooth

Bluetooth is a short-range wireless communications technology. Phones with Bluetooth capabilities can exchange information within a distance of about 30 feet without requiring a physical connection.

Bluetooth modes

Bluetooth on your phone operates in three different modes:

1. **On.** Bluetooth is turned on. Your phone can detect other Bluetooth-enabled devices, but not vice versa.
2. **Off.** Bluetooth is turned off. In this mode, you can neither send nor receive information using Bluetooth.
3. **Visible.** Bluetooth is turned on, and all other Bluetooth-enabled devices within range can detect your phone.

Note By default, Bluetooth is turned off. If you turn it on and then turn off your phone, Bluetooth also turns off. When you turn on your phone again, Bluetooth automatically turns on.

To turn Bluetooth on or off on your phone

You can enable Bluetooth capability by selecting the Bluetooth button in the Comm Manager. You can also do the following:

1. On the Home screen, select **Start > Settings > Connections > Bluetooth**.
2. Select **Bluetooth > Menu > Turn On Bluetooth**.

To turn off Bluetooth capabilities on your phone, select **Bluetooth > Menu > Turn Off Bluetooth**.

To make your phone visible

1. On the Home screen, select **Start > Settings > Connections > Bluetooth**.
2. Select **Bluetooth > Menu > Turn On Visibility**.

Tip Enter a Bluetooth phone name for your phone. This will be the phone name that will be shown on another Bluetooth-enabled device when it searches and detects your phone. To enter a name on the Bluetooth screen, select **Security** and then enter a **Device name**.

Bluetooth partnerships

A Bluetooth partnership is a relationship that you create between your phone and another Bluetooth-enabled device in order to exchange information in a secure manner.

To create a Bluetooth partnership

1. On the Home screen, select **Start > Settings > Connections > Bluetooth**.
2. Select **Bluetooth > Add new device**.
Your phone searches for other Bluetooth-enabled devices and lists them.
3. Select the desired device name in the list and then select **Next**.
4. Enter a passcode (up to 16 characters) to establish a secure connection and then select **Next**.
5. Wait for the paired device to accept the partnership.

6. On your phone, a message will appear, indicating that your phone has connected with the paired device. Select **Done**. The paired device is then displayed in the Bluetooth Devices screen.
7. Select the paired device and select **Menu > Edit** to enter a display name for that device and then select **Next**.
8. Select the check boxes of services that you want to use from the paired device and then select **Done**.

To accept a Bluetooth partnership

1. Ensure that Bluetooth is turned on and in Visible mode.
2. Select **Yes** when prompted to establish a partnership with the other device.
3. Enter a passcode (the same passcode that is entered on the device requesting the partnership) to establish a secure connection.
4. Select **Next**.
5. On your phone, a message will appear, indicating that your phone has connected with the paired device. Select **Done**. The paired device is then displayed in the Bluetooth Devices screen.
6. Select the paired device and select **Menu > Edit** to enter a display name for that device and then select **Next**.
7. Select the check boxes of services that you want to use from the paired device.
8. Select **Done**. You can now exchange information with the other device.

To change the display name of a Bluetooth device

1. On the Home screen, select **Start > Settings > Connections > Bluetooth**.
2. Select **Bluetooth** and then on the screen, select a Bluetooth device.
3. Select **Menu > Edit**.
4. Enter a new display name for the Bluetooth device and then select **Next**.
5. Select **Done**.

To delete a Bluetooth partnership

1. On the Home screen, select **Start > Settings > Connections > Bluetooth**.
2. Select **Bluetooth** and then on the screen, select a Bluetooth device.
3. Select **Menu > Delete** and then select **Yes** in the confirmation screen.
4. Select **Done**.

Connect a Bluetooth hands-free or stereo headset

For hands-free phone conversations or to listen to music, you can use a Bluetooth hands-free or stereo headset.

Note To listen to music using a wireless headset, you need to use a Bluetooth stereo headset.

To connect a Bluetooth hands-free or stereo headset

1. Make sure that both your phone and the Bluetooth headset are turned on and within close range, and that the headset is visible. Refer to the manufacturer's documentation to find out how to set the headset in Visible mode.
2. On the Home screen, select **Start > Settings > Connections > Bluetooth**.
3. Select **Bluetooth > Add new device**. Your phone searches for other Bluetooth-enabled devices and displays them in the list.

4. Select the name of the headset and then select **Next**.
5. If you are prompted for a passcode, enter the alphanumeric passcode for the Bluetooth headset and then select **Next**. The passcode is usually “0000” or “1234”. If these do not work, then refer to the headset documentation for the code.
A message will appear saying that your phone has connected to the headset.
6. Select **Advanced**.
7. Enter the display name for the headset, and then select **Next**.
8. Select the check boxes for the **Wireless Stereo** (if available) and **Hands Free** services, and then select **Done**.

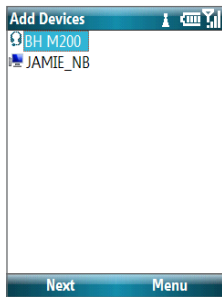

Note If the Bluetooth stereo headset becomes disconnected, turn the headset on and repeat steps 1 and 2 above. Select the stereo headset and select **Menu > Set as Wireless Stereo**.

Beam information using Bluetooth

You can beam information, such as contacts, calendar items, and tasks, as well as files from your phone to your computer or to another Bluetooth-enabled device.

Notes

- If your computer does not have built-in Bluetooth capabilities, you need to connect and use a Bluetooth adapter or dongle on your computer.
- Before beaming items to your computer, open Bluetooth Configuration or Bluetooth Settings in the Control Panel and check if there's an option for setting a location for saving beamed items.

To beam information from your phone to a computer

1. On your phone, set Bluetooth to Visible mode. For information about this, see “To make your phone visible”.
2. On your computer, set Bluetooth to Visible mode, create a Bluetooth partnership, and then enable your computer to receive Bluetooth beams.
If your computer has Windows Vista or Windows XP SP2 and your computer’s Bluetooth adapter is supported by your Windows version, do the following steps:
 - a. On your computer, open **Bluetooth Devices** from the Control Panel and then click the **Options** tab.
 - b. For **Windows Vista**, select **Allow Bluetooth devices to find this computer**.
For **Windows XP**, select **Turn discovery on** and **Allow Bluetooth devices to connect to this computer**.
 - c. Create a Bluetooth partnership between your phone and computer. For information about creating a partnership, see “Bluetooth partnerships”.
 - d. In the **Options** tab of **Bluetooth Devices**, select **Show the Bluetooth icon in the notification area**.
 - e. To enable your computer to receive Bluetooth beams, right-click the Bluetooth icon at the bottom-right of your computer screen and then select **Receive a File**.
3. Now you are ready to beam. On your phone, select an item to beam, such as an appointment in your calendar, a task, a contact card, or a file.
4. Select **Menu > Beam [type of item]**.
5. Select the device name to which you want to beam.
6. Select **Beam**.
7. If you beamed a calendar, task, or contact item to your computer and it is not automatically added to Outlook, select **File > Import and Export** to import it to Microsoft Outlook on your computer.

To beam information to a Bluetooth-enabled device such as another phone, create a Bluetooth partnership then do steps 3 through 6 in the above procedure.

Tip The default folder on your computer where beamed items are stored may be:
Windows XP: C:\Documents and Settings\your_username\My Documents
Windows Vista: C:\users\your_username\My Documents.

8.9 Windows Live™

Windows Live™ gives you full Internet experience on your phone. It makes it easier for you to find information, pursue your interests, and get in touch with friends and family on the Internet.

Windows Live™ offers the following key features:

- **Live Search Bar**, lets you search for information on the Web.
- **Live Messenger**, the next generation of MSN Messenger Mobile.
- **Live Mail**, the next generation of Hotmail.
- **Live Search**, lets you find locations, browse maps, and check for directions.
- **Live Contacts**, address book for storing Live Mail, Live Messaging, and Hotmail contacts.

Set up Windows Live™

The first time you use Windows Live™, sign in by using your Windows Live ID, which is your Windows Live Mail or Hotmail address, and password.

To set up Windows Live for the first time

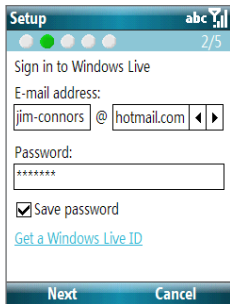

1. On the Home screen, scroll down to  on the Shortcut Bar and then select **Set Up E-mail**.
2. On the Select Account screen, select **Windows Live Hotmail**.
3. On the Windows Live screen, select **Sign in to Windows Live**.
4. On the next screen, select the links to read the Windows Live™ Term of Use and the Microsoft Privacy Statement. After reviewing them, select **Accept**.
5. Enter your Windows Live Mail or Hotmail address and password, then select **Next** twice.



Setup abc  2/5

Sign in to Windows Live

E-mail address:

@  

Password:

Save password

[Get a Windows Live ID](#)

Next Cancel

- Choose what information you want to synchronize online with your phone.

If you choose to synchronize **Store Windows Live contacts in your mobile phone's contact list**, your online contacts will be added to the contact list and to Windows Live Messenger on your phone.

If you choose **Sync E-mail**, your Windows Live Mail or Hotmail inbox messages will be downloaded to your phone.

- Select **Next**.
- After synchronization is complete, select **Done**.

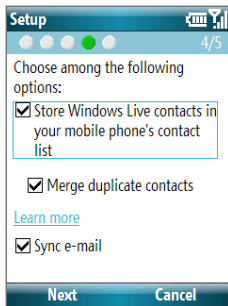

The Windows Live™ interface

On the main interface of Windows Live™, you will see a search bar, navigation bar, and an area where you can customize to show your picture.

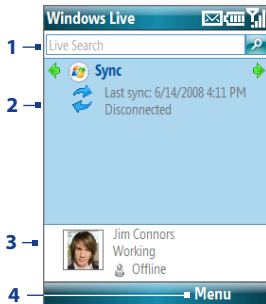

- Windows Live Search bar.
- Press **NAVIGATION WHEEL** left or right to switch among Live Mail, Messenger, and Sync status. Select to open/activate the selected Windows Live component.
- Select to access Windows Live Messenger settings.
- Select **Menu** to access and change settings.

8.10 Windows Live™ Messenger

Windows Live™ Messenger lets you send and receive instant messages online. With this mobile version of Windows Live Messenger, you enjoy many of the same cool features that you get from the desktop version, which include the following:

- Instant messaging via text and voice
- Multiple conversations
- Add emoticons
- Contact list with presence
- Send and receive files including photos
- Change status/display name
- View contacts by online status, groups, and more
- Send messages even when a contact is offline

Notes

- Before you can use Live Messenger, your phone must be connected to the Internet. For information about setting up an Internet connection, see “Ways of Connecting to the Internet” in this chapter.
- You also need to have a T-Mobile data plan to use Live Messenger.

Launch the messenger and sign in

To open Live Messenger

Do one of the following:

- On the Home screen, select **Start > Instant Messaging > Messenger**.
- On Windows Live of the Home screen, press NAVIGATION WHEEL left or right until you see **Messenger** and then press ENTER.

To sign in and out

1. To sign in, select **Sign in** on the messenger screen.
2. If this is your first time to sign in, a message appears informing you that your messenger contacts will be added to the contact list on your phone. Select **OK** to add them.

Signing in may take several minutes depending on your connection speed.

3. To sign out, select **Menu > Sign Out**. Your status changes to **Offline**.

Add Windows Live™ contacts

You can add new Windows Live™ contacts in Live Messenger or in Contacts.

To add a Windows Live™ contact in Live Messenger

1. Select **Menu > Add new contact**.
2. Enter the e-mail address of the contact and then select **OK**.

To add a Windows Live™ contact in Contacts

1. On the Home screen, select **Start > Contacts**.
2. Select **New** and then select **Windows Live**.
3. In the **IM** box, enter the e-mail address of the contact, which can be a Windows Live ID or any other e-mail address.

Tip You can fill in other information about the contact, if desired. This is not absolutely necessary if you will communicate with the contact only through Windows Live™ Messenger or Live Mail.

4. Select **Done**.
5. Follow the remaining instructions to add the new contact to your Windows Live™ contact list.

To delete a contact

1. In the messenger, select the contact and then select **Menu > Contact options > Remove contact**.
2. Choose whether to block the contact.
3. Choose whether to also delete the contact from your phone's contact list.
4. Select **OK**.

Send instant messages

You can send instant messages with emoticons and even talk by sending a voice clip. While chatting, you can send and receive files directly on a message window. You can also start conversations with several contacts and switch between their message screens, or you can invite participants to join in a conversation.

To start and end conversations

1. In the contact list, select a contact and then select **Send IM** to open a message screen.
2. Send an instant message. See "To send an instant message with emoticon" for details.
3. To start a conversation with another contact, press **NAVIGATION WHEEL** left/right to return to the contact list, select another contact, and then select **Send IM** again. Another message screen opens.
4. To switch from one message screen to another, press **NAVIGATION WHEEL** left/right to the display picture of the contact with whom you want to talk.

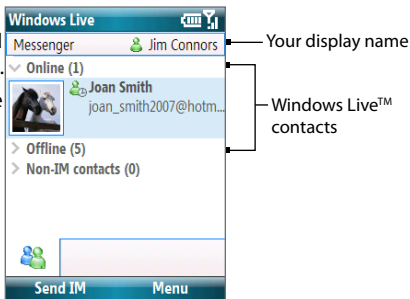

5. To end a conversation with the current contact, select **Menu > End conversation**.
6. To end all active conversations, select **Menu > End all conversations**.

To send an instant message with emoticon

1. Select a contact and start a conversation.
2. Enter your text message in the text entry area of the message screen.
3. To add an emoticon, select **Menu > Add emoticon** and then select an icon from the list of emoticons.
4. Select **Send**.

Tips

- To send a file, select **Menu > Send**. You can choose to send a picture, voice clip, or any file.
- To invite one or more contacts to the conversation, select **Menu > Options > Add participant**.

To send a voice message

1. Select a contact and then start a conversation.
2. Select **Voice clip** and then start talking.
3. After you have recorded a message, select **Send**.

Personalize the messenger

While on the contacts list, you can do the following:

- Select **Menu > Change status** to set your current status (such as Busy, Out to lunch, and more) so that your contacts will know whether you're available.
- Select **Menu > Change appearance** to change your display name, add a personal message, and add your picture.
- Select **Menu > Sort by** to organize contacts by online status, groups, name, or e-mail address. You can also hide offline contacts from the contact list.
- Select **Menu > Add new contact** to add a new Live Messenger contact.
- Select **Menu > Contact options** to open a menu where you can view contact properties, block the contact, remove the contact, and more.
- Select **Options** to see more settings.

8.11 Windows Live™ Search

Windows Live™ Search is a separate program that offers you a fast, easy way to find and view maps and local information on your phone. With Windows Live™ Search, you can:

- Browse through local listings of categories.
- Locate nearby restaurants, shopping centers, etc., and check for their street addresses and phone numbers.
- View maps with directions to and from a location.
- View traffic information.

To open Windows Live™ Search

Select **Start > Internet Applications > Live Search**.

To find a location

1. Specify first where the location is near. You can select from the list of cities.

You can also select **Choose a new location** to enter a city, select on a map, or get a contact's address.

Tip Windows Live Search allows you to speak the name of the business. Select **Speak** and say the name clearly.

2. Enter the location that you want to find and then press **CENTER SELECT**.
3. The Search Results screen then shows a list of matched places. Use the Navigation Control to browse through the list. As you browse, the address, phone number, and estimated distance of a selected item are displayed.
4. Select the desired location in the Search Results screen.
5. On the Details screen:
 - a. Select **Map** to see the location on a map.
 - b. Select **Directions to Here** for instructions on how to reach the location.

Note If you connect a Bluetooth GPS receiver and set it up on your phone, Live Search can track your current position. You can use your current position as a starting point for finding a desired location. See the user manual of your GPS device for more details.

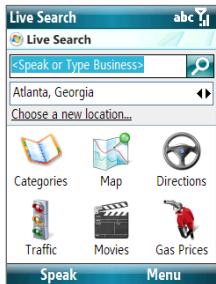

Chapter 9

Experiencing Multimedia

9.1 Camera

9.2 Photo & Video Album

9.3 Windows Media® Player Mobile

9.4 Java Applications

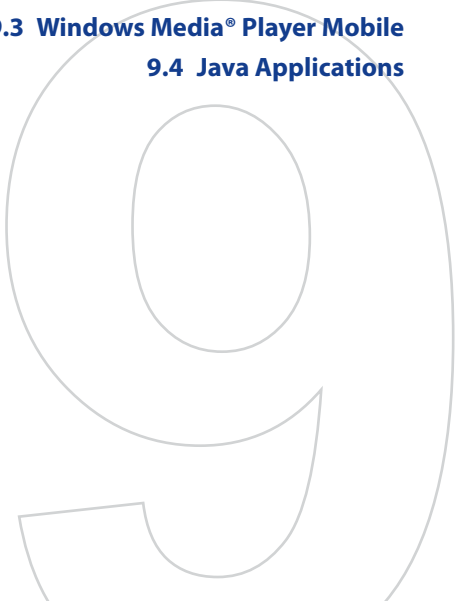

9.1 Camera

Taking photos and shooting video clips are easy with your phone's built-in camera.

To open Camera

Do any of the following:

- Press the **CAMERA** button on the right side of the phone.
- On the Home screen, select **Start > Camera**.

Turning the device automatically switches the screen orientation between landscape and portrait mode.

To exit Camera

Press  .

Note Pressing  simply "minimizes" the Camera program, it is still running in the background. To close the Camera program, go to Task Manager.

Take a photo or capture a video clip







Aim the camera at the subject and then press **CENTER SELECT** to take the shot. When capturing video, press **CENTER SELECT** to start recording; press it again to stop.

Capture modes

The Camera program lets you capture pictures and video clips by using various built-in modes.

The title bar displays the active capture mode.

The available capture modes are as follows:

Capture mode	Function
Photo ()	Captures standard still images.
Video ()	Captures video clips, with or without audio.
Video Messaging ()	Captures video clips suitable for sending via MMS.
Contacts Picture ()	Captures a still image suitable for assigning as an identification photo to a contact.
Picture Theme ()	Captures still images and places them within frames.
Sports ()	Captures a sequence of still images (3 or 5 frames) automatically for a short duration at a defined frequency.

Using the above capture modes, the camera captures files in the following formats:

Capture type	Format
Still Image	JPEG
Video	Motion-JPEG AVI (.avi) MPEG-4 (.mp4) H.263 baseline (.3gp)
Video Messaging	MPEG-4 (.mp4) H.263 baseline (.3gp)

To change the capture mode

On the Camera screen, press **NAVIGATION WHEEL** right or left until you see the capture mode icon you want to use on the upper-left part of the screen.

Camera mode icons and indicators

The camera icons and indicators disappear from the screen after **3** seconds. Press one of the **SOFT KEYS** to make them reappear.

The Camera [Photo] screen

- 1 Indicates the current capture mode.
- 2 Indicates the current zoom ratio. Press **NAVIGATION WHEEL** up or down to increase or decrease the zoom level.
- 3 Select (Left **SOFT KEY**) to open the Camera Settings screen.
- 4 Depending on the capture mode, this shows the remaining, available shots of pictures that you can take or remaining duration that can be recorded. While recording video, this shows the recorded duration.
- 5 Select (Right **SOFT KEY**) to open Photo & Video Album.



The Camera [Video] screen

The Recording Status indicator **REC** blinks while video recording is in progress.







Quick Settings Menu

The Quick Settings Menu provides a quick way for adjusting some camera settings. Select  on the screen to open the menu.

Note The available settings on the menu depend on the selected Capture mode.

Press **NAVIGATION WHEEL** up or down to select the setting you want to change. Press **NAVIGATION WHEEL** left or right to go through the options per setting and then press **CENTER SELECT** to choose the option.



Icon	Function
	Select the Self-timer option for capturing images: Off , 2 seconds , or 10 seconds . Selecting 2 seconds or 10 seconds delays the capturing by the specified time after you press CENTER SELECT .
	Increase or decrease the brightness level. When selected, press NAVIGATION WHEEL left or right to adjust the brightness.
	Only available in Picture Theme mode. Lets you select a template to use for Picture Theme mode.
	Choose the resolution to use when capturing video or images.
	Specify the white balance setting such as Auto , Daylight , Night , Incandescent , and Fluorescent to suit the lighting environment.

Tip You can also rotate the **NAVIGATION WHEEL** clockwise or counterclockwise to adjust the settings.

Use zooming

Before capturing a still image or a video clip, you can first zoom in to make the object in focus move closer, and you can zoom out to make the object move farther away. In all capture modes, press **NAVIGATION WHEEL** up on your phone to zoom in or press **NAVIGATION WHEEL** down to zoom out.

Tip You can also rotate the **NAVIGATION WHEEL** clockwise or counterclockwise to zoom in and out.

The camera zoom range for a picture or video depends on the capture mode and capture size. Also, note the capture sizes available for certain capture formats also vary from one capture mode to another.

Tip To know if zooming is possible for the selected resolution and/or format, check if the zoom images (i.e. the arrows and trees) on the left side of the screen appear or not. If you do not see these images, zooming is not possible.

Quick Send

Quick Send lets you quickly send photos you have taken using the phone camera to your online T-Mobile album or journal account or a contact via e-mail or Picture Message.

Note Quick Send is only available in Photo mode. When capturing video and Quick Send is enabled, the Review screen appears after you stop capturing. See "The Review screen" below for details.



Select (Left **SOFT KEY**) to open the Quick Send options screen.

Select (**CENTER SELECT** key) to take another photo without sending the current photo.

Select (Right **SOFT KEY**) to send the photo to the default destination.

To change Quick Send settings

Quick Send options let you send the photo to another destination, edit the message before you send out the photo, set the photo as a myFaves icon, change the default destination, and more. You can access the Quick Send options by selecting **Options** on the Quick Send screen.

To change the default destination

1. On the Camera screen, select **Menu > Settings > Quick Send Pictures tab > Destination > Customized**.

Note You must be in the Photo capture mode to be able to see the Quick Send tab.

Tip You can also change the default destination on the Quick Send screen by selecting **Options > Default Destination > Change**.

2. On the Change screen, select the new destination and then select **Select**.
3. On the confirmation screen, select **OK** to change the default destination.

To disable Quick Send

By default, the Quick Send screen appears after you have taken a photo using one of the supported capture modes.





To disable the Quick Send screen, on the Camera screen, select **Menu > Settings > Quick Send tab > Quick Send > Off**.

Note When Quick Send is disabled, the Review screen will appear after capturing a photo or video.

The Review screen



After capturing a photo or video, you will be presented with options that you can do with the captured media file.

Note The Review screen only appears after a photo or video is captured when Quick Send is disabled or the capture mode is not supported by Quick Send.

Icon	Function
	Select to return to the Camera screen.
	Select to delete the captured image or video clip.
	Select to send the captured image or video clip to someone via e-mail or Picture Message.
	Select to switch to Photo & Video Album to show the still image, or switch to Windows Media® Player to play back the video clip.
	Select to associate the photo to a selected contact. (Contacts Picture mode)

Note After you have taken photos in **Sports** mode, the total number of consecutive shots is shown at the upper right corner of the Review screen. Press **NAVIGATION WHEEL** up or down to browse through the sequence of photos.

Camera Capture and Advanced Settings

Select  >  on the Camera screen to open the Camera settings screen where you can add a picture effect, change the quality, customize capture settings, adjust camera display properties, and more.

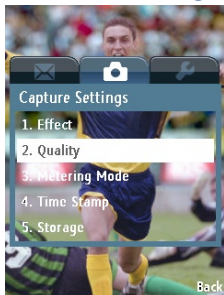

Capture Settings

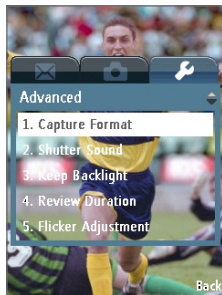

Advanced

To change Capture Settings or Advanced settings

1. Press **NAVIGATION WHEEL** left/right to select either the **Capture Settings** or **Advanced** tab.
2. Press **NAVIGATION WHEEL** up/down to choose the setting to change. When a setting is selected, press **CENTER SELECT** to see the available options for the particular setting.
3. Choose the option you want and then press **CENTER SELECT**.
4. Select **Back** to close the Settings screen.

Press **CENTER SELECT** to open the options associated with the item.

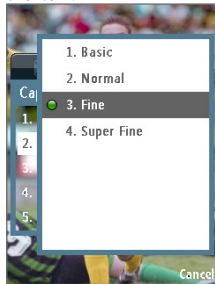

9.2 Photos & Video Album

View images that you captured using the Camera program in Photo & Video Album. Photo & Video Album offers a host of features that let you view your images as a slide show, use images as contact pictures, and more.

Note Only files supported by the Camera program are displayed in Photo & Video Album. To know which file formats are supported, see “File formats supported” in the Camera section.

To open Photo & Video Album

Do one of the following:

- Select **Start > Photo & Video Album**.
- In the Camera program, select .

To view an image

On the main Photo & Video Album screen, select the thumbnail of the image you want to view and press **CENTER SELECT**.

Tip To go back to the main Photo & Video Album screen while viewing an image, press the **BACK** key.

To go to the next image

Go to the next image by pressing **NAVIGATION WHEEL** right.

Go back to the previous image by pressing **NAVIGATION WHEEL** left.



To zoom in or out of an image

While viewing an image, scroll the **NAVIGATION WHEEL** clockwise to zoom in. To zoom out, scroll the **NAVIGATION WHEEL** counterclockwise.

- Tips**
- When you zoom in on an image, press **CENTER SELECT** to automatically zoom out and fit the image to the screen.
 - When you zoom in on an image, press the **NAVIGATION WHEEL** up/down/left/right to pan the image.

To view the images as a slide show

On the Photo & Video Album screen, select **Menu > Slide Show**. While viewing the slide show, you can:

- Press **CENTER SELECT** to pause and resume the slide show playback.
- Press **NAVIGATION WHEEL** right to go to the next image.
- Press **NAVIGATION WHEEL** left to go back to the previous image.

You can set slide show preferences by selecting **Menu > Options** on the main Photo & Video Album screen.

To view a different Album

Select **Albums > My Device** and browse to the location of the desired album. To view all pictures on your device select **Albums > All**.

To close Photo & Video Album and go to the Camera program

Go back to the main Photo & Video Album screen and select .

9.3 Windows Media® Player Mobile

You can use Windows Media® Player Mobile to play digital audio and video files that are stored on your phone or on a network, such as on a Web site.

To open Windows Media® Player Mobile

Select **Start > Windows Media**.

About the controls

By default, these hardware buttons are assigned to Windows Media® Player Mobile functions.

Tip To change the assigned hardware buttons, on the Playback screen, select **Menu > Options > Buttons**.

To	Press
Play or pause	CENTER SELECT
Skip to a previous file	NAVIGATION WHEEL left
Skip to the next file	NAVIGATION WHEEL right
Increase the volume	NAVIGATION WHEEL up
Decrease the volume	NAVIGATION WHEEL down
Turn the sound on or off quickly (mute)	#
Switch to full screen during video playback	0
Change rating	*
Fast-forward a file	NAVIGATION WHEEL right (hold)
Rewind a file	NAVIGATION WHEEL left (hold)

About the screens and menus

Windows Media® Player Mobile has three primary screens:

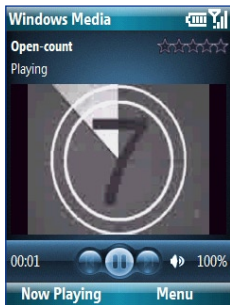

Playback screen

The default screen that displays the playback controls and the video window.



Now Playing screen

This special playlist indicates the current file being played and files that are queued up to play next.

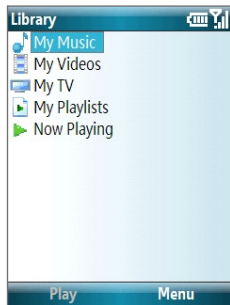

Library screen

The screen that lets you quickly find your audio files, video files, and playlists.

When you copy new media files to your phone, select **Menu > Update Library** to update the library contents.

Select **Menu** to open a list of options that you can do in a particular screen. The commands on this menu vary depending upon which screen you are viewing.

About licenses and protected files

Some media files have associated licenses that protect them from being unlawfully distributed or shared.

If you want to copy a protected file from your PC to your phone, use the Windows Media® Player on your PC to synchronize the file to your phone. This will ensure that the license is copied along with the protected file. For more information about synchronizing files to your phone and other mobile devices, see the “Windows Media® Player Help.”

Note You can view the protection status for a file by checking its file properties (**Menu > Properties**).

Synchronize video and audio files

Install Microsoft Windows Media® Player 11 on your PC to synchronize digital media files from your PC to your device. This ensures that protected files and album art (for skins) are copied to your phone correctly.

To synchronize content to your phone automatically

1. On your PC, start Windows Media® Player and then connect your phone to your PC.
2. In the Device Setup Wizard, select **Yes, Search my computer now**.

Note Skip this step if you have previously searched your PC for media files using Windows Media Player.

3. The Device Setup Wizard then shows the device name (or shows “Storage Card” if you have inserted one on your phone). Click **Finish**.
4. On the leftmost pane of Windows Media® Player, right-click your phone and then click **Set Up Sync**.

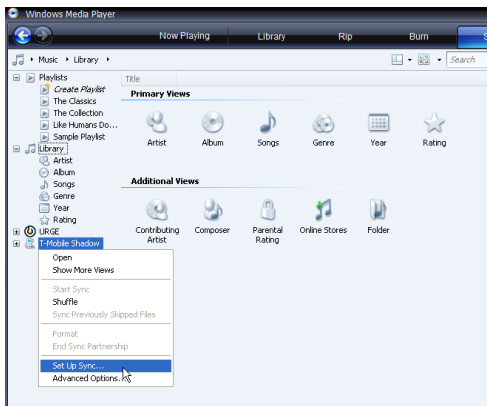

Note You can also sync your storage card if you have one installed on your phone. To set up media synchronization, right-click **Storage Card** and then click **Set Up Sync**.

5. On the Device Setup dialog box, select **Sync this device automatically**.
6. If you created your own playlists, select your desired playlist(s) from the list box at the left, then click **Add** to add them to the list of playlists to sync on the right.

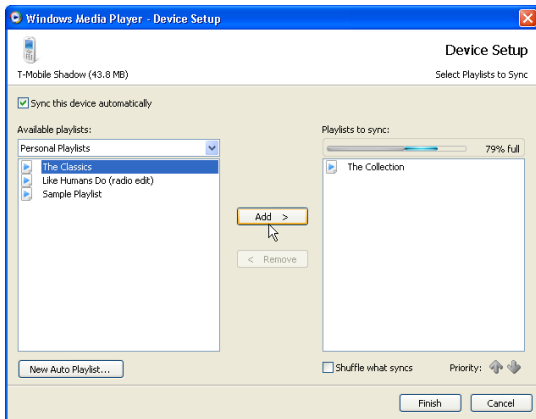

7. Click **Finish**.

The files begin synchronizing to your phone. The next time you connect your phone to your PC while Windows Media® Player is running, synchronization will start automatically.

See "Play media" for instructions on how to play media files.

To synchronize content manually to your phone

1. If you have not set up synchronization between your phone and PC, follow steps 1 through 3 in "To synchronize content to your phone automatically."
2. Click the **Sync** tab on the Windows Media® Player.
3. Select a Playlist or a Library on the left panel of the Windows Media® Player.

- From the content list, drag files you want to sync to your phone to the right panel of the Windows Media® Player.
- Click **Start Sync** to start copying files to your phone.

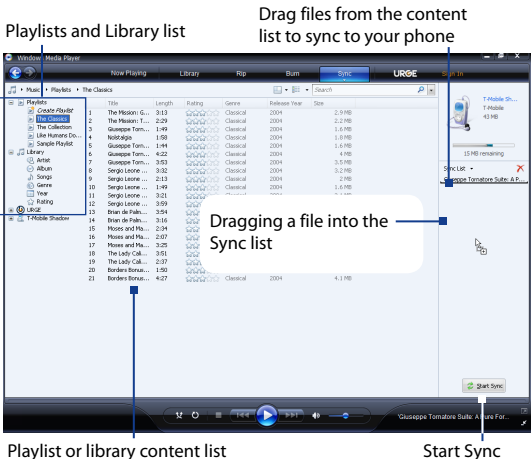

Notes

- Use Windows Media® Player 11 or later on your PC to synchronize (copy) media files to your phone.
- Audio files copy faster if Windows Media® Player is configured to automatically set the quality level for audio files copied to your phone. For more information, see the "Windows Media® Player Help."

Play media

Use the library to find and play songs, videos, and playlists that are stored on your phone or storage card.

To update the Library

You need to update the Library in Windows Media® Player Mobile first before you can view and play media on your device.

1. Select **Start > Windows Media**.
2. On the Library screen, select **Menu > Update Library** to update the library list.

Tip If you do not see the Library screen when you open Windows Media® Player Mobile, select **Menu > Library** to go to the Library.

3. Select **Done**.

To play video and audio files on your phone

1. Select a category (for example, **My Music** or **My Playlists**).
2. Select the item that you want to play (such as a song, album, or artist name) and then select **Play**.

Note To play a file that is stored on your phone but is not in a library, on the Library screen, select **Menu > Open File**. Select the item that you want to play (such as a file or a folder) and then select **Play**.

Playlists

A playlist is a list of digital media files that play in a specified order. By using playlists, you can group audio and video files together for convenient playback.

In Windows Media® Player on your PC, you can create playlists and synchronize them with your phone.

In Windows Media® Player Mobile on your phone, playlists are available in the Library under the My Playlists category. There is also a temporary playlist, called Now Playing, which lists the currently playing file as well as any files that have been queued up to play next. You can create a new playlist on your device by saving the current Now Playing playlist and giving it a new name.

To save a new playlist

1. If you are not on the Library screen, select **Menu > Library**.
2. Select a category (for example, My Music or My Playlists).
3. Select a media file that you want and then select **Menu > Queue Up**. This adds the file to the Now Playing list.

Repeat this step until you have added all desired media files to the Now Playing list.

Note You cannot select multiple files simultaneously.

4. After adding the media files, select **Menu > Now Playing**.
5. On the Now Playing screen, select **Menu > Save Playlist**.
6. Enter the playlist name and then select **Done**.
7. To play back the playlist you created, select **My Playlists** in the Library, select your playlist, and then select **Play**.

Troubleshooting

For more information, see the Troubleshooting Windows Media® Player Mobile page at the Microsoft Web site (<http://www.microsoft.com/windows/windowsmedia/player/windowsmobile/troubleshooting.aspx>).

9.4 Java Applications

MIDlets are Java™-based applications that can run on mobile devices. Your phone supports Java 2 Edition, J2ME™. Java lets you download Java-based applications, such as games and tools that are specifically designed for mobile devices. Java gives you the flexibility of installing and managing additional J2ME applications from the Internet.

Install and run MIDlets/MIDlet suite

To install MIDlets from the Internet

1. On the Home screen, select **Start > Applications > Java Applications**. The Java screen appears.
2. Select **Install > Download** to open Internet Explorer® Mobile.
3. Locate the MIDlet/MIDlet suite while connected to the Internet.
4. Select the MIDlet/MIDlet suite to download.
5. Select **Yes** to start installing the MIDlet/MIDlet suite.
6. After the MIDlet is installed, you will see a prompt asking you if you want to run the MIDlet, select **Yes**.

Notes

- You can cancel the installation at any time.
- Downloaded MIDlets/MIDlet suites will be automatically saved in the My Documents folder.

To install MIDlets from a PC

You can install the MIDlets/MIDlet suites on your phone from a PC using the USB sync cable or Bluetooth. MIDlets copied to your phone using Bluetooth or e-mail attachments are automatically saved in the My Documents folder.

To install MIDlets from a local folder

1. On the Home screen, select **Start** > **Applications** > **Java Applications**. The Java screen appears.
2. Select **Install** > **Local Install** to install the MIDlets on your phone.
3. Select the MIDlet/MIDlet suite from the list by using the **NAVIGATION WHEEL** and then press **CENTER SELECT**.
4. Select Yes.
5. After the MIDlet is installed, you will see a prompt asking you if you want to run the MIDlet, select **Yes**.

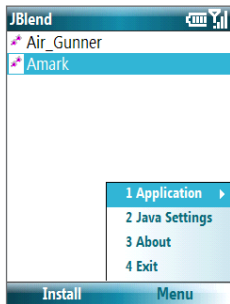

To run MIDlets/MIDlet suites on your phone

1. On the Home screen, select **Start** > **Applications** > **Java Applications**. The Java screen appears.
2. Select a MIDlet/MIDlet suite from the list by using the **NAVIGATION WHEEL**.
3. Press **CENTER SELECT**.

Manage MIDlets

You can delete installed MIDlets as well as set program permissions for MIDlet applications. Select **Menu > Application**.

From here you can do any of the following.

- **Delete** Uninstall the selected MIDlet.
- **Delete All** Uninstall all MIDlets.
- **Permissions** Open a window to set JBlend permissions.
- **Info** Display MIDlet version information.
- **Update Info** Update version information.
- **Settings** Set the connection to use when connecting to the Internet.

Chapter 10

Using Other Applications

10.1 Microsoft® Office Mobile

10.2 Microsoft® Office Word Mobile

10.3 Microsoft® Office Excel® Mobile

10.4 Microsoft® Office PowerPoint® Mobile

10.5 Microsoft® Office OneNote® Mobile

10.6 Adobe® Reader® LE

10.7 Speed Dial

10.8 Voice Command

10.1 Microsoft® Office Mobile

Microsoft® Office Mobile includes four applications that let you view and edit Microsoft documents. These four applications are:

- **Microsoft® Office Word Mobile** lets you view and edit Word documents and text files.
- **Microsoft® Office Excel® Mobile** lets you view and edit Excel worksheets.
- **Microsoft® Office PowerPoint® Mobile** lets you view PowerPoint slides.
- **Microsoft® Office OneNote® Mobile** lets you easily create notes with audio and images.

To learn how to copy files, see “Managing and Backing Up Files” in Chapter 4.

10.2 Microsoft® Office Word Mobile

Microsoft® Office Word Mobile gives you editing and viewing capabilities for your Word documents and text files.

To open Word Mobile

Select **Start > Office Mobile > Word Mobile**.

Note Word Mobile does not fully support some features of Microsoft Word. Some data and formatting may be lost when you save the document on your phone.

View documents

To open a document

1. In Word Mobile, select **Menu** and choose the location where the **.doc**, **.rtf**, or **.txt** file is saved.
2. Locate the file you want to open and then select **Select**.

Note You can only open one document at a time. You must close the opened document first before you can open another document.

To change the zoom ratio

Select **View** and then on the menu, select the zoom ratio to use.

Select **View > Wrap to Window** to adjust the text flow so that the text wraps based on the screen size. This way, you do not need to scroll right to read long paragraphs or sentences.

Note You cannot wrap text in tables.

To change scrolling preference

Select **Menu > Scroll Up/Down** and then select **By Page** or **By Line**.

To find a word in a document

1. Select **Menu > Find**.
2. Type in the word you want to find in **Find What**. Select **Match case** and/or **Whole words only** if needed.
3. Select **Find**.

To close the document

Select **Menu > Close File**.

Edit and send documents

To edit Word documents or text files, you need to switch to Edit mode. Select **Menu > Edit** to switch to Edit mode.

To type words into the document

1. In the document, use the **NAVIGATION WHEEL** to position the cursor where you want to insert the text.

Tip Select **Menu > Format** to change the font format. You can use **Bold**, **Italic**, **Underline**, and **Highlight**.

2. Type in the text using the QWERTY keyboard.

Tip Select **Menu > Format** and select a formatting style such as bold, italic, and so on to apply and remove the formatting.

To save the document

1. Select **Menu > File > Save As**.
2. Type in the **Name** you want to use for the edited document and then select the **Location** where you want to save the document.
3. Select **Save**.

To send the document through e-mail

1. Select **Menu > File > Send**.
2. In the Messaging screen, select the E-mail account you want to use to send the document and then select **Select**.
3. In the e-mail, the file is automatically appended as an attachment.
4. Enter the recipient name and then select **Send**.

10.3 Microsoft® Office Excel® Mobile

Microsoft® Office Excel® Mobile gives you editing and viewing capabilities for your Excel worksheets.

To open Excel Mobile

Select **Start > Office Mobile > Excel Mobile**.

Note Excel Mobile does not fully support some features such as Microsoft Excel. Some data and formatting may be lost when you save the workbook on your phone.

View worksheets

To open a file

1. In Excel Mobile, select **Menu** and then choose the location where the **.xls** file is saved.
2. Locate the file you want to open and then select **Select**.

Note You can only open one worksheet at a time. You must close the opened worksheet first before you can open another worksheet.

By default, the worksheet opens in Full Screen mode. To change the view mode, press the left **SOFT KEY** to show the View menu and then select **View > Full Screen**.

To view the contents of a cell

There are times that the text in a cell cannot be fully displayed onscreen. To view the text in the cell in its entirety, select the cell and then select **View > Cell Text**.

To immediately view an area in the worksheet

1. In the worksheet, select **View > Overview**.
2. Use the **NAVIGATION WHEEL** to move the rectangular marquee to the area you want to view.
3. Press **CENTER SELECT**.

To use Freeze Pane

1. Select the cell that is after and below the row and column you want to freeze. For example, if you want to freeze **column E** and **row 4**, you should select cell **F5**.
2. Select **View > Freeze Panes**. To unfreeze the panes, select **View > Unfreeze Panes**.

To change the zoom ratio

Select **View > Zoom** and then select the zoom ratio to use.

To switch to another worksheet

If your Excel file has multiple worksheets, you can go to a different worksheet by selecting **View > Sheet** and then select the worksheet you want to view.

Edit and send worksheets

To edit Excel worksheets, you need to switch to Edit mode. Select **Menu > Edit** to switch to Edit mode.

To edit the cell text

1. Select the cell whose text you want to edit and then select **Menu > Edit > Cell Text**.
2. Type in the text and then select **Done**.

To delete the cell content

Select the cell whose content you want to delete and then select **Menu > Edit > Clear Cell**.

Tip You can select multiple cells by selecting **Menu > Select** and then choosing what to select in the worksheet.

To edit the cell range of a defined name

If your worksheet contains defined names created in Microsoft Excel on the PC, you can edit the cell range of the defined name.

1. Select **Menu > Edit > Define Name**.
2. In **Range Name**, select the name whose cell range you want to change.
3. In **Refers to**, type in the new cell range.
4. Select **Done**.

To delete cells

Select the cell you want to delete and then select **Menu > Edit > Delete Cells**.

Tip You can select multiple cells to delete by selecting **Menu > Select** and then choosing what to select in the worksheet.

To copy and paste cell contents

1. Select the cell(s) you want to copy and then select **Menu > Edit > Copy**.

Tip You can select multiple cells to copy by selecting **Menu > Select** and then choosing what to select in the worksheet.

2. Select the cell(s) where you want to copy the cell contents to and then select **Menu > Edit > Paste**.

To insert a row or column

Select the cell where you want to insert a row or column and then select **Menu > Insert > Row** or **Column**. If you insert a row, the row will be inserted above the selected cell; if you insert a column, the column will be inserted at the left of the selected cell.

Tip You can also shift the contents of a row or column. To shift, select the cell you want to shift and then select **Menu > Insert > Shift Right** or **Shift Down**.

To go to a cell

1. Select **Menu > Tools > Go To** and then enter the **Cell reference or name**.
2. Select **OK**.

Tip You can also sort and find text in the worksheet by selecting **Menu > Tools > Sort** or **Find**.

To undo and redo an action

Select **Menu > Undo [Action]** or **Redo [Action]**.

To save the worksheet

1. Select **Menu > File > Save As**.
2. Type in the **Name** you want to use for the edited worksheet and then select the **Location** where you want to save the worksheet.
3. Select **Save**.

To send the worksheet through e-mail

1. Select **Menu > File > Send**.
2. In the Messaging screen, select the E-mail account you want to use to send the worksheet.
3. In the e-mail, the file automatically appends as an attachment.
4. Enter the recipient name and then select **Send**.

10.4 Microsoft® Office PowerPoint® Mobile

Microsoft® Office PowerPoint® Mobile gives viewing capabilities for your PowerPoint presentations.

To open PowerPoint Mobile

Select **Start > Office Mobile > PowerPoint Mobile**.

To open a file

1. In PowerPoint Mobile, select **Menu** and then choose the location where the **.ppt** file is saved.
2. Locate the file you want to open and then select **Select**.

To go through the slides of the presentation

Press **NAVIGATION WHEEL** right to go forward in the presentation; press **NAVIGATION WHEEL** left to go back to the previous action or slide of the presentation.

You can also go to a particular slide in your presentation by pressing the right **SOFT KEY** (to show the Menu) and selecting **Menu > Go to Slide**, then choosing the slide to go to.

To view a custom show

You can view custom shows that you created in Microsoft PowerPoint on your computer on your phone.

1. Press the right **SOFT KEY** to show the menu.

2. Select **Menu > Custom Show** and then select the custom show you want to view from the list.

To zoom in on a slide

1. Press the right **SOFT KEY** to show the menu.
2. Select **Menu > Zoom In**.
3. Use the **NAVIGATION WHEEL** right, left, up, and down to pan the slide when zoomed in.

Note You cannot go to the next or previous slide when you zoom in. You need to zoom out first to go to the next or previous slide. To zoom out, select **Menu > Zoom Out**.

To set PowerPoint Mobile preferences

1. Press the right **SOFT KEY** to show the menu.
2. Select **Menu > Options**.
3. Set the **Orientation** and **Playback options**, and then select **Done**.

To show links in a slide

You can show and activate hyperlinks in slides that you created in Microsoft PowerPoint on your phone.

1. Press the right **SOFT KEY** to show the menu.
2. Select **Menu > Show Links**.
3. Press **CENTER SELECT** to activate the hyperlink. If there is more than one hyperlink on the slide, use the **NAVIGATION WHEEL** to select the hyperlink you want to activate.

To end the presentation

Press the right **SOFT KEY** (to show End) and then select **End**.

10.5 Microsoft® Office OneNote® Mobile

Microsoft Office® OneNote® Mobile lets you easily create notes with audio and images. Create the notes in your phone, then synchronize them with your PC to keep your OneNote files current.

Note You need an ActiveSync partnership between your computer, phone, and Microsoft Office OneNote to synchronize OneNote files.

To open OneNote Mobile

Select **Start > Office Mobile > OneNote Mobile**.

OneNote Mobile opens with the list of notes in your phone. Select **Menu** to rename a file and set the sort order for the list.

To create a new OneNote file

1. In OneNote Mobile, select **New**.
2. Enter the note by typing in text or by adding pictures or audio. You can do the following when creating your note.
 - To add an audio file into the note, select **Menu > Insert Recording**.
 - To take a picture and add it into the note, select **Menu > Take Picture**.
 - To add a picture from file into the note, select **Menu > Insert Picture**.
 - To create a bulleted or numbered list, select **Menu > List > Numbered or Bulleted**.
 - To change the text format, select **Menu > Format**.

Tip If you are using a formatting style and you want to revert to no formatting style, select **Menu > Format** and then select the formatting style you are using from the menu.

3. After completing the note, select **Done**.

10.6 Adobe® Reader® LE

Adobe® Reader® LE lets you view Portable Document Format (PDF) files.

When you open a password-protected PDF file, you will be prompted to enter the password before you can open the file.

To open a PDF file on your phone

1. Select **Start > Applications > Adobe Reader LE**.
2. Select **Open**.
3. Browse to a folder and then select the PDF file you want to open.

Note To open another PDF file, select **Open > Menu > Browse For File**. You can also open a PDF file from File Explorer by selecting it.

To navigate through a PDF file

You can do any of the following:

- Use the **NAVIGATION WHEEL** to scroll through the pages.
- Select **Menu > Go To** and then select an option to go to a specific page in the PDF file.

While reading a PDF file, select **Menu** to open a list of options that lets you zoom in, directly go to a bookmark, find text in the file, and more.

10.7 Speed Dial

You can create speed dial entries for frequently called numbers or frequently accessed items so you can dial a number or access an item by pressing a single key.

To create a speed dial entry for a contact

1. On the Home screen, select **Start > Contacts**.
2. Select a contact.

3. Press **CENTER SELECT** to view the contact details.
4. Select the desired phone number and then select **Menu > Add to Speed Dial**.
5. Enter the appropriate details in the Name, Value, and Keypad assignment.
6. Select **Done**. To quit at any time during this process, select **Menu > Cancel**.

To create a speed dial entry for an item

1. On the Home screen, select **Start** and then choose (just highlight) the item you want.
2. Select **Menu > Add Speed Dial**.
3. Enter the details in the Name, Value, and Keypad assignment.
4. Select **Done**. To quit at any time during this process, select **Menu > Cancel**.

Note The first speed dial location is generally reserved for your voice mail. Speed Dial uses the next available location by default. If you want to place a number in a location that is already used, the new number replaces the existing number.

To retrieve a voice mail message

On the Home screen, press and hold  to access your voice mailbox, and then follow the prompts to retrieve your messages.

To make a call or launch a program using Speed Dial

If you have assigned a speed dial (for example, the second location) to a contact or a program in Speed Dial, you can simply press and hold the **2** key on the phone keyboard to dial the contact's number or to open the program.

To delete a speed dial entry

1. On the Home screen, select **Start > Applications > Speed Dial**.
2. Select the desired entry and then select **Menu > Delete**.

10.8 Voice Command

Voice Command lets you call your contacts, open applications, play back music, and get calendar information just by using your voice.

Voice Command only responds to a set of predefined commands. You cannot create your custom commands in Voice Command.

To learn more about the commands that you can use, select **Start > Applications > Voice Command > Menu > Help**.

To set the Voice Command button

You need to set a button on your phone as the Voice Command button for you to enable and disable it. See “Shortcut Key” in Chapter 1 to see instructions on setting shortcut keys.

When Voice Command is activated, the  icon will appear at the top-right corner of the screen.

You can set other options on the Voice Command screen. To learn about the different options, consult the Voice Command help.

To call a contact

1. Hold the phone a few inches away from your mouth.
2. Press and hold the **SHORTCUT KEY** to activate Voice Command.
3. In a clear voice, say “Call [Contact Name].”
4. Voice Command will confirm with you the contact you want to call. After the Voice Command confirmation, say “Yes” or “Correct.”

Note If Voice Command is wrong about the contact to call, say “No” or “Incorrect” to try again.

5. The phone calls the contact.

To show the contact card of a contact

This will only show contacts that are saved on the phone.

1. Hold the phone a few inches away from your mouth.
2. Press and hold the **SHORTCUT KEY** to activate Voice Command.
3. In a clear voice, say “Show [Contact Name]” or “Lookup [Contact Name].”

To request information from your calendar

1. Hold the phone a few inches away from your mouth.
2. Press and hold the **SHORTCUT KEY** to activate Voice Command.
3. In a clear voice, say the information you want to retrieve. For example, “What’s my next appointment?” or “What’s my next meeting?”

Consult the Voice Command help file to learn the other commands that you can use to retrieve other Calendar information.

To open a program

1. Hold the phone a few inches away from your mouth.
2. Press and hold the **SHORTCUT KEY** to activate Voice Command.
3. In a clear voice, say “Open [Program Name].”

Tip You can also say “Show [Program Name]” or “Start [Program Name]” to open programs. Use the phrase that you are most comfortable with.

To request phone status information

1. Hold the phone a few inches away from your mouth.
2. Press and hold the **SHORTCUT KEY** to activate Voice Command.
3. In a clear voice, say the phone status information you want to retrieve. For example, say “What time is it?” or “What date is it?”

Consult the Voice Command help file to learn the other commands that you can use to retrieve other phone status information.

To get help in using Voice Command

1. Hold the phone a few inches away from your mouth.
2. Press and hold the **SHORTCUT KEY** to activate Voice Command.
3. In a clear voice, say “Help.”

To use Voice Command with a Bluetooth headset

Activate Voice Command from your Bluetooth headset by pressing the voice dial button on the Bluetooth headset.

For more information about Voice Command, visit <http://www.microsoft.com/windowsmobile/voicecommand/default.aspx>

Appendix

A.1 Specifications

A.2 Regulatory Notices

A.1 Specifications

System information

Processor/Chipset • TI's OMAP™ V1030, 260MHz

Memory

- ROM: 256 MB (Standard)
- RAM: 128 MB DDR
- Free memory: 144 MB
- Available program storage: 74 MB
(variable, depending on installed applications)

(The first two figures above are the total ROM and RAM memory available for use and storage. Since the memory is shared by the Operating System, applications, and data, the actual available memory is less than what is written).

Operating system Windows Mobile® 6.1 Standard

Display

Type 2.6-inch Transmissive QVGA LCD with white LED back light

Resolution 240 x 320 dots resolution at 65K Colors

GSM/GPRS/EDGE Quad-band module

GSM 850 824 ~ 849, 869 ~ 894 MHz

GSM 900 880 ~ 915, 925 ~ 960 MHz

GSM 1800 1710 ~ 1785, 1805 ~ 1880 MHz

GSM 1900 1850 ~ 1910, 1930 ~ 1990 MHz

Camera module

Type	2 Megapixel CMOS
Resolution	<ul style="list-style-type: none">• UXGA: 1600 x 1200• SXGA: 1280 x 960• VGA: 640 x 480• QVGA: 320 x 240• QQVGA: 160 x 120

Connections

I/O port	HTC ExtUSB™ : 11-pin mini-USB and audio jack in one (ExtUSB is a proprietary connection interface that is trademarked by HTC)
-----------------	---

Bluetooth	V 2.0 EDR, Class 2 transmit power
------------------	-----------------------------------

Wi-Fi	IEEE 802.11b/g compliant, internal WLAN antenna
--------------	---

UMA	<ul style="list-style-type: none">• Transparent rove in/out to UMAN including discovery and registration• Dynamic handover to/from GERAN• Dynamic handover between access points in UMAN
------------	--

Audio

Ring tone	<ul style="list-style-type: none">• Software polyphonic and standard MIDI format 0 and 1 (SMF)/SP MIDI• AAC+, AAC, AMR-NB, AMR-WB, QCP, MP3, MP4, WMA, and WAV
------------------	---

Physical**Dimension** 4.05 inches (L) x 2.05 inches (W) x 0.6 inches (T)**Weight** 0.26 lbs with battery pack**Controls and lights****Navigation** Navigation wheel with 4-way navigation/Center Select Key**Buttons**

- Volume buttons
- Left and Right Softkeys
- Home screen
- Back to previous screen
- Send (start call/answer call)
- End call/Power
- Side Button (Customizable)
- Camera
- 20-key QWERTY keyboard

Lights

- Event notification
- Charge status
- GSM/GPRS/EDGE signals
- Wi-Fi and Bluetooth connections

Expansion slot**microSD slot** microSD™ memory card

Power supply	
Battery	Li-ion 1100 mAh removable, rechargeable battery
Talk time	GSM/UMA: Up to 8 hours
Standby	GSM: Up to 160 hours UMA: Up to 100 hours
AC adapter	<ul style="list-style-type: none">• AC input/frequency: 100 ~ 240 AC, 50/60Hz• DC output: 5V and 1A

A.2 Regulatory Notices

Regulatory Agency Identifications

For regulatory identification purposes, your product is assigned a model number of **CONV100**.

To ensure continued reliable and safe operation of your phone, use only the accessories listed below with your **CONV100**.

The Battery Pack has been assigned a model number of **CONV160**.

This product is intended for use with a certified Class 2 Limited Power Source, rated 5 Volts DC, maximum 1 Amp power supply unit.

Federal Communications Commission Notice

This device complies with part 15 of the FCC Rules. Operation is subject to the following two conditions: (1) This device may not cause harmful interference, and (2) this device must accept any interference received, including interference that may cause undesired operation.

This equipment has been tested and found to comply with the limits for a Class B digital device, pursuant to Part 15 of the FCC Rules. These limits are designed to provide reasonable protection against harmful interference in a residential installation. This equipment generates, uses, and can radiate radio frequency energy and, if not installed and used in accordance with the instructions, may cause harmful interference to radio communications. However, there is no guarantee that interference will not occur in a particular installation. If this equipment does cause harmful interference to radio or TV reception, which can be determined by turning the equipment on and off, the user is encouraged to try to correct the interference by one or more of the following measures:

- Reorient or relocate the receiving antenna.
- Increase the separation between the equipment and receiver.
- Connect the equipment into an outlet on a circuit different from that to which the receiver is connected.
- Consult the dealer or an experienced radio or television technician for help.

Modifications

The FCC requires the user to be notified that any changes or modifications made to the device that are not expressly approved by High Tech Computer Corporation may void the user's authority to operate the equipment.

Cautions

In August 1996 the Federal Communications Commission (FCC) of the United States with its action in Report and Order FCC 96-326 adopted an updated safety standard for human exposure to radio frequency electromagnetic energy emitted by FCC regulated transmitters. Those guidelines are consistent with the safety standard previously set by both U.S. and international standards bodies. The design of this phone complies with the FCC guidelines and these international standards. Use only the supplied or an approved antenna. Unauthorized antennas, modifications, or attachments could impair call quality, damage the phone, or result in violation

of FCC regulations. Do not use the phone with a damaged antenna. If a damaged antenna comes into contact with the skin, a minor burn may result. Please contact your local dealer for replacement antenna.

Body-worn operation

This device was tested for typical body-worn operations with the back of the phone kept **1.5 cm** from the body. To maintain compliance with FCC RF exposure requirements, use only belt-clips, holsters or similar accessories that maintain a **1.5 cm** separation distance between the user's body and the back of the phone, including the antenna. The use of belt-clips, holsters and similar accessories should not contain metallic components in its assembly. The use of accessories that do not satisfy these requirements may not comply with FCC RF exposure requirements, and should be avoided.

Safety precautions for Radio Frequency (RF) exposure

Use only original manufacturer-approved accessories, or accessories that do not contain any metal

Use of non-original manufacturer-approved accessories may violate your local RF exposure guidelines and should be avoided.

Exposure to RF Signals

Your device contains a radio transmitter and receiver. The radiated output power is far below the international radio frequency exposure limits. These limits are part of comprehensive guidelines and establish permitted levels of RF energy for the general population. The guidelines are based on the safety standards previously set by international standards bodies:

- American National Standards Institute (ANSI) IEEE. C95.1-1992
- National Council on Radiation Protection and Measurement (NCRP). Report 86. 1986
- International Commission on Non-Ionizing Radiation Protection (ICNIRP) 1996
- Ministry of Health (Canada), Safety Code 6. The standards include a substantial safety margin designed to assure the safety of all persons, regardless of age and health.

The exposure standard for wireless mobile phones employs a unit of measurement known as the Specific Absorption Rate, or SAR. The standard incorporates a substantial margin of safety to give additional protection for the public and to account for any variations in usage.

As with other mobile radio transmitting equipment, users are advised that for satisfactory operation of the equipment and for the safety of personnel, it is recommended that no part of the human body be allowed to come too close to the antenna during operation of the equipment.

Your device has an internal antenna. Use only the supplied integral antenna. Use of unauthorized or modified antennas may impair call quality and damage the phone, causing loss of performance and SAR levels exceeding the recommended limits as well as result in non-compliance with local regulatory requirements in your country.

To assure optimal phone performance and ensure human exposure to RF energy is within the guidelines set forth in the relevant standards; always use your device only in its normal-use position. Do not touch or hold the antenna area unnecessarily when placing or receiving a phone call. Contact with the antenna area may impair call quality and cause your device to operate at a higher power level than needed. Avoiding contact with the antenna area when the phone is IN USE optimizes the antenna performance and the battery life.

Tests for SAR are conducted using standard operating positions specified by the FCC with the phone transmitting at its highest certified power level in all tested frequency bands. Although the SAR is determined at the highest certified power level, the actual SAR level of the phone while operation can be well below the maximum value. This is because the phone is designed to operate at multiple power levels so as to use only the power required to reach the network. In general, the closer you are to a wireless base station antenna, the lower the power output. Before a phone model is available for sale to the public, it must be tested and certified to the FCC that it does not exceed the limit established by the government-adopted requirement for safe exposure. The tests are performed in positions and locations (for example, at the ear and worn on the body) as required by the FCC for each model. (Bodyworn measurements may differ among phone models, depending upon available accessories and FCC requirements). For body worn operation, to maintain compliance with FCC RF exposure guidelines, use only original manufacturer approved accessories. When carrying the phone while it is on, use the specific original manufacturer supplied or approved carrying case, holster, or other body-worn accessory.

SAR Information

- 1.38 W/kg @ 1g

Telecommunications & Internet Association (TIA) safety information

Pacemakers

The Health Industry Manufacturers Association recommends that a minimum separation of six inches be maintained between a handheld wireless phone and a pacemaker to avoid potential interference with the pacemaker. These recommendations are consistent with the independent research by and recommendations of Wireless Technology Research. Persons with pacemakers:

- Should ALWAYS keep the phone more than six inches from their pacemaker when the phone is turned ON.
- Should not carry the phone in a breast pocket.
- Should use the ear opposite the pacemaker to minimize the potential for interference. If you have any reason to suspect that interference is taking place, turn your phone OFF immediately.

Hearing Aids

Some digital wireless phones may interfere with some hearing aids. In the event of such interference, you may want to consult your service provider, or call the customer service line to discuss alternatives.

Other Medical Devices

If you use any other personal medical device, consult the manufacturer of your device to determine if they are adequately shielded from external RF energy. Your physician may be able to assist you in obtaining this information.

Turn your phone OFF in health care facilities when any regulations posted in these areas instruct you to do so. Hospitals or health care facilities may be using equipment that could be sensitive to external RF energy.

Heed service markings

Except as explained elsewhere in the Operating or Service documentation, do not service any product yourself. Service needed on components inside these compartments should be done by an authorized service technician or provider.

Damage requiring service

Unplug the product from the electrical outlet and refer servicing to an authorized service technician or provider under the following conditions:

- Liquid has been spilled or an object has fallen into the product.
- The product has been exposed to rain or water.
- The product has been dropped or damaged.
- There are noticeable signs of overheating.
- The product does not operate normally when you follow the operating instructions.

Other tips and cautions

- Avoid using your phone near metal structures (for example, the steel frame of a building).
- Avoid using your phone near strong electromagnetic sources, such as microwave ovens, sound speakers, TV and radio.
- Avoid using your phone after a dramatic change in temperature.

WEEE Notice

The Directive on Waste Electrical and Electronic Equipment (WEEE), which entered into force as European law on 13th February 2003, resulted in a major change in the treatment of electrical equipment at end-of-life.

The purpose of this Directive is, as a first priority, the prevention of WEEE, and in addition, to promote the reuse, recycling and other forms of recovery of such wastes so as to reduce disposal.



The WEEE logo (shown at the left) on the product or on its box indicates that this product must not be disposed of or dumped with your other household waste. You are liable to dispose of all your electronic or electrical waste equipment by relocating over to the specified collection point for recycling of such hazardous waste. Isolated collection and proper recovery of your electronic and electrical waste equipment at the time of disposal will allow us to help conserving natural resources. Moreover, proper recycling of the electronic and electrical waste equipment will ensure safety of human health and environment. For more information about electronic and electrical waste equipment disposal, recovery, and collection points, please contact your local city centre, household waste disposal service, shop from where you purchased the equipment, or manufacturer of the equipment.

RoHS Compliance

This product is in compliance with Directive 2002/95/EC of the European Parliament and of the Council of 27 January 2003, on the restriction of the use of certain hazardous substances in electrical and electronic equipment (RoHS) and its amendments.

Index

A

Accessibility settings

- confirmation time out 84
- in-call alert volume 84
- multipress time out 83
- system font size 83

ActiveSync 74

- overview 46
- synchronize 75, 144

Add and remove programs 85

Add attachment to message 129

Adobe Reader 46, 225

Alarm 83

Alarm settings 81

Alerts 81

Answer/end call 66

AOL/AIM 127

Attachments 130

Audio Postcards 49, 121

B

Backlight brightness 84

Backlight time out 84

Back up files 86

Battery

- battery information 57
- battery management 84
- low battery 58

Beam

- via Bluetooth 183

Block Picture Message 119

Bluetooth

- beaming 183
- Bluetooth modem 178
- hands-free headset 182
- modes 179
- overview 179
- partnerships 180
- stereo headset 182
- synchronize 77
- visible 179

Browsing the Web 175

C

Calculator 46

Calendar 47, 105

Call History 47

Camera 194

- icons and indicators 196
- overview 47
- zoom 198

Camera settings 201

Capture formats 195

Capture modes 195

Check battery power 58

Clear Storage 47

Clock & Alarm 46

Comm Manager 47, 50, 160

Company Directory 153

Compose

- Picture Message 118
- Compose messages 129

- Conference call 68
- Confirmation time out 84
- Connecting to Wi-Fi Network 165
- Connect phone to Internet
 - Dial-up 173
 - Wi-Fi 161
- Connect phone to private network 173
- Contacts 47, 94
 - Beam contact information 96
 - Call a contact 95
 - Create a new contact 94
 - Find a contact 95
 - Send contact information via a text message 96
 - Send contact information via MMS 96
 - View and edit a contact 95
- Contacts picture (capture mode) 195
- Copy
 - contacts to SIM card 97
 - files between phone and PC 86
 - media files from PC to device 206
 - SIM contacts to phone 97
 - sound file to phone 82
- Currency setting 81
- Customize Home screen 80

D

- Date setting 81
- Device lock 91
- Dial-up connection 173
- Digitally sign messages 155, 157

- Digital Rights Management (DRM) 206
- Digital signature
 - verify 156
- Direct Push 145
- Display time out 84

E

- E-mail 129
 - security 155
 - settings (POP3/IMAP4) 133
- Emergency call 69
- Encrypt messages 155, 157
- Enter text and numbers 52
- Event notification 81
- Excel Mobile 48, 218
- Exchange Server 138
 - schedule synchronization 145
- Exclude e-mail address when replying to all 134

F

- Fetch Mail 147
- File Explorer 46, 87
- Filter e-mail 130
- Find contact
 - online 153
- Flag your messages 149
- Font size (display) 83
- Forward message 131

G

Games 47
GPRS 172

H

Handango InHand 48
Help 47
Home screen

- change background 80
- customize 80
- overview 41, 80

HotSpot Settings 50
HotSpot Status 50

I

IMAP4 127, 128
In-call alert volume 84
Insert a long pause in dialing sequence 69
Insert pause in dialing sequence 69
Insert SIM Card 35
Install

- Microsoft ActiveSync 74

Install Micro SD Card 37
Install MIDlets

- from Internet 212
- from PC 212
- locally 213

Instant Messaging 48
International call 69
Internet 161

Internet Explorer Mobile 48, 175
Internet Sharing 47, 177

J

Java

- manage MIDlets/MIDlet suites 214

Java Applications 46, 212

K

Keyboard

- shortcuts 135

L

LED indicator lights 34
Licensed and protected media 206
Live Messenger 188
Live Search 48, 192
Lock the phone 89
Lock the phone (Password) 91

M

Make call

- from Call History 64
- from Contacts 64
- from Home Screen 63
- from Speed Dial 65

Managing Meeting Requests 151
Memory 85
Messaging 48

- overview 112

- Picture messages 117
- Text messages 113

Messenger 48, 188

microSD 33

Mobile Backup 47, 109

Modem

- Bluetooth modem 178
- USB modem 177

Multipress mode 54

Mute call 68

myFaves 48, 99

N

Number format 81

Numeric mode 56

O

Office Mobile 216

- Excel Mobile 218
- PowerPoint Mobile 222
- Word Mobile 216

OneNote Mobile 48, 224

Operating system version 84

Out-of-office 150

Outlook E-mail 128

Owner information 83

P

Parts and accessories 30

Pause in dialing sequence 69

PDF 225

Personal information 83

Phone program 61

Phone specification 85

Photo & Video Album 49, 202

Photo (capture mode) 195

Picture Message 117

- Create and send 117

Picture theme (capture mode) 195

PIN 88

Playlists 210

Play media 210

POP3 127, 128

Power management 84

PowerPoint Mobile 48, 222

Profile 81

Programs 46

- ActiveSync 46
- Adobe Reader 46
- Audio Postcards 49
- Calculator 46
- Calendar 47, 105
- Call History 47
- Camera 47
- Clear Storage 47
- Clocks & Alarm 46
- Comm Manager 47, 50
- Contacts 47, 94
- Excel Mobile 48
- File Explorer 87
- Games 47

- Getting Started 47
 - Handango InHand 48
 - HotSpot Settings 50
 - HotSpot Status 50
 - Instant Messaging 48
 - Internet Explorer 48
 - Internet Sharing 47, 177
 - Java 212
 - Java Applications 46
 - Live Search 48
 - Messaging 48, 112
 - Messenger 48
 - myFaves 48
 - OneNote Mobile 48
 - Phone 61
 - Photos & Video Album 49
 - PowerPoint Mobile 48
 - Set Up E-Mail 49
 - SIM Manager 47, 97
 - Speed Dial 46, 225
 - Task Manager 49, 85
 - Tasks 46, 108
 - Video Recorder 49
 - Voice Command 46
 - Voice Recorder 46
 - Windows Live 48, 185
 - Windows Media Player Mobile 50, 204
 - Word Mobile 48
- Put call on hold 67

Q

- Quick List 51
- Quick Send 198
- Quick Settings Menu 197
- QWERTY keyboard 52

R

- Receive
 - call 66
 - Picture Message 119
- Regional settings 81
- Reply
 - Picture Message 119
- Reply message 131, 134
- Reset phone 92
- Restart phone 92
- Review screen 200
- Ring tone 62, 110
- Run MIDlets 213

S

- Search for e-mails on the Exchange Server 148
- Secure/Multipurpose Internet Mail Extension (S/MIME) 155
- Securing Wi-Fi Connection 169
- Send
 - e-mail/SMS message 129
 - Picture message 117
- Send and download e-mails 132

- Send appointments 107
- Send messages 129
- Settings 49
- Set up ActiveSync on PC 74
- Set Up E-Mail 49, 127
- Set up Home screen 80
- Share contact information 96
- SharePoint 150
- Shortcut Bar 42
- Shortcut Key 58
- Shortcuts 135
- SIM Manager 47
 - copy contacts to SIM card 97
 - copy SIM contacts to phone 97
 - create SIM contact 97
- Sounds 81
- Speakerphone 68
- Speed Dial 46, 65, 225
- Sports (capture mode) 195
- Start menu 51
- Status Indicators 59
- Stop programs 85
- Swap/switch calls 67
- Synchronize
 - ActiveSync 75
 - change information types 76
 - music and video 78
 - Outlook information with computer 75
 - schedule synchronization with Exchange Server 145
 - via Bluetooth 77

- Windows Media Player 78
- Windows Media Player Mobile 206
- System font size 83

T

- T-Mobile HotSpot
 - HotSpot Settings 50
 - HotSpot Status 50
- t-zones 49
- T9 mode 54
- Task Manager 49, 85
- Tasks 46, 108
- Time setting 81
- Troubleshooting
 - sync connection problems 76

U

- UMA
 - About 165
- Using Instant Messaging 122
 - AIM 122
 - ICQ 124
 - Yahoo! 125

V

- Verify digital signature 156
- Video (capture mode) 195
- Video Messaging (capture mode) 195
- Video Recorder 49
- View and reply to Picture Messages 119

View your appointments 106
Visible (Bluetooth) 180
Voice Command 46
Voice Recorder 46, 110
Volume Control 33

W

Web browser 175
Wi-Fi 161
Windows Live 48, 185
Windows Live Mail 127
Windows Live Messenger 188
Windows Media Player
- file formats 204
- menus 205
- overview 50
- troubleshooting 211
Windows Media Player Mobile
- playlists 210
Windows Mobile Device Center 73
Windows Mobile software version 84
Word Mobile 48, 216

Y

Yahoo! 127

Z

Zoom 198